

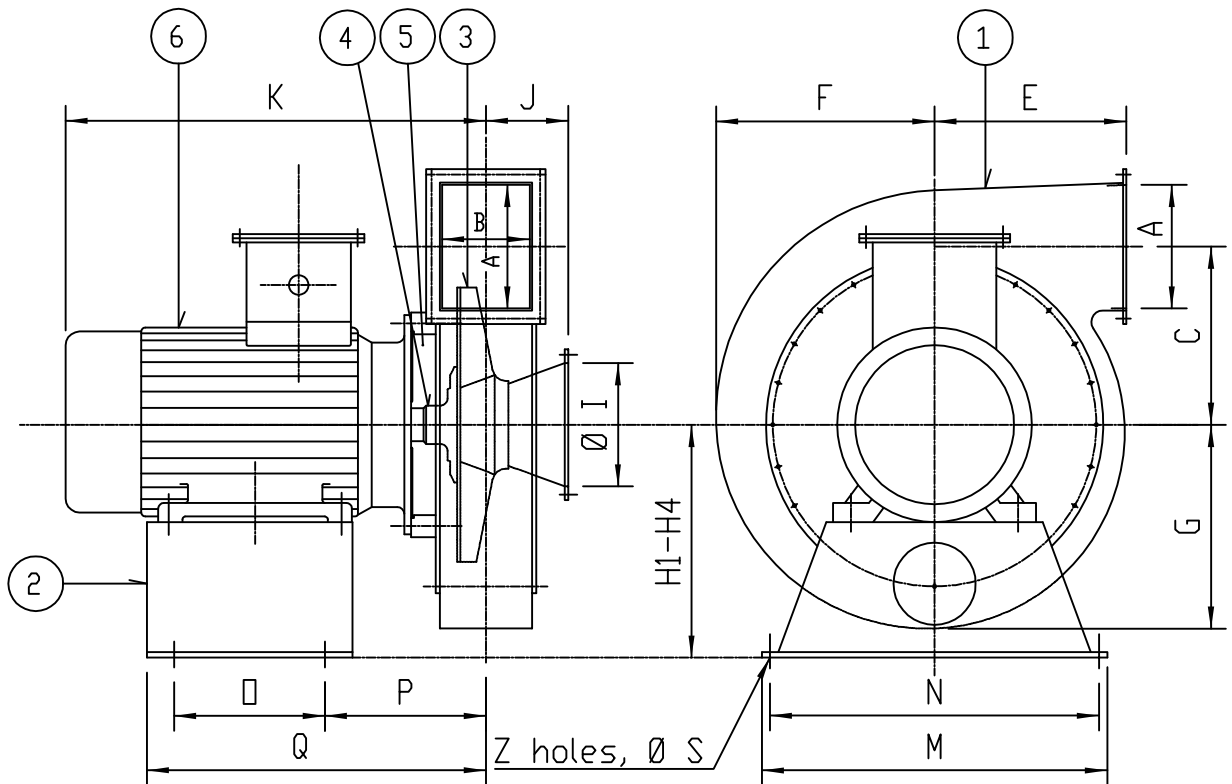

HIGH PRESSURE CENTR. FAN

DIMENSION DRAWING

HSV - B1



FAN SIZE	A= Ø I	B	C	E	F	G	H1	H2	H3	H4	J	K	M	N	O	P	Q	Z	S	weight ex cl motor [kg]
150	150	120	280	300	326	297	400	350	350		120		540	500						15
180	180	140	300	325	365	330	450	400	350		120		580	500						21
210	210	170	350	350	400	365	500	450	400		130		610	560						26
250	250	200	375	375	440	400	550	450	450		150		700	650						72
300	300	240	450	450	530	480	675	550	500		170		800	750						97
350	350	240	500	500	605	540	750	650	550		210		800	750						
400	400	300	550	550	660	660	800	700	650		250		1000	900						
450	450	350	625	600	740	680	900	800	700		235		1100	1000						
500	500	400	700	700	830	740	1030	900	800		270		1200	1100						
600	600	460	750	750	900	820	1150	950	850		320		1300	1200						
700	700	640	880	880	1065	950	1300	1150	1000		350		1500	1420						

Mounting Positions in accordance to "Eurovent"

Configurations to be seen from shaft side.

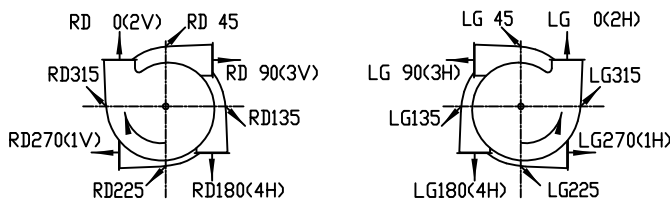

- ① FAN HOUSING.
Matl.:
- ② MOTOR PEDESTAL.
Matl.:
- ③ FAN IMPELLER.
Matl.: Salt and amoniaresistive aluminium alloy.
- ④ SHAFT SEAL OR GASTIGHT ASSEMBLY.
If Applicable
- ⑤ AIR GAP BETWEEN MOTOR AND SEAL.
If Applicable
- ⑥ EL.MOTOR: Model:
Kw: Rpm: V: Hz:

Date: 11.10.96

4-1154-m

Drawn: M.Berge

N Y B O R G A S

N-6230 SYKKYLVEN - NORWAY

Tel: +47 70 25 40 80 - Fax +47 70 25 29 08

E-MAIL: office@nyborgfan.com - WEB: www.nyborgfan.com

HSV - B1



HIGH PRESSURE CENTR. FAN

Dimensional Sketch

HSV - B3

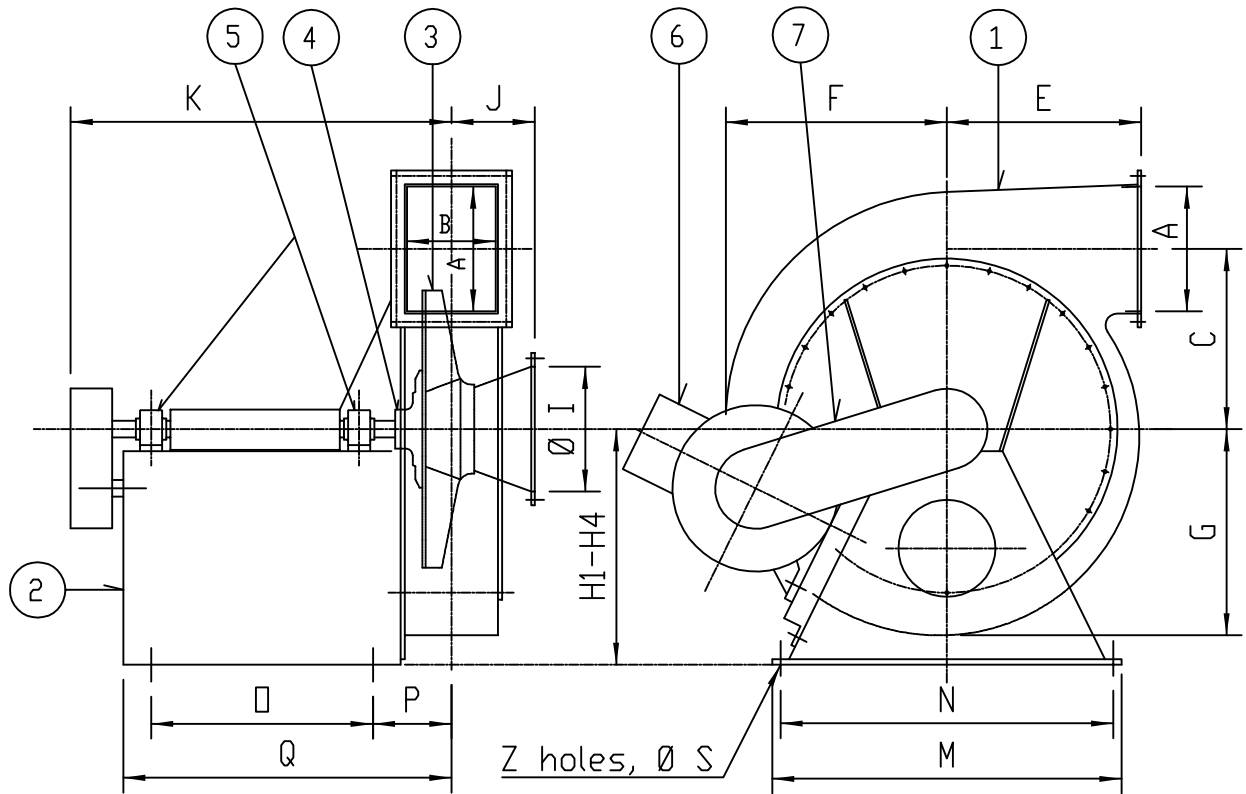

SIZE NO	A= Ø I	B	C	E	F	G	H1	H2	H3	H4	J	K	M	N	Ø	P	Q	Z	S
150	150	120	280	300	326	297	400	350	350		120		540	500					
180	180	140	300	325	365	330	450	400	350		120		580	500					
210	210	170	350	350	400	365	500	450	400		130		610	560					
250	250	200	375	375	440	400	550	450	450		150		700	650					
300	300	240	450	450	530	480	675	550	500		170	690	800	750	330	150	520	4	14
350	350	240	500	500	605	540	750	650	550		210		800	750					
400	400	300	550	550	660	660	800	700	650		250		1000	900					
450	450	350	625	600	740	680	900	800	700		235		1100	1000					
500	500	400	700	700	830	740	1030	900	800		270		1200	1100					

Mounting Positions in accordance to "Eurovent"

Configurations to be seen against motor (Drive end)

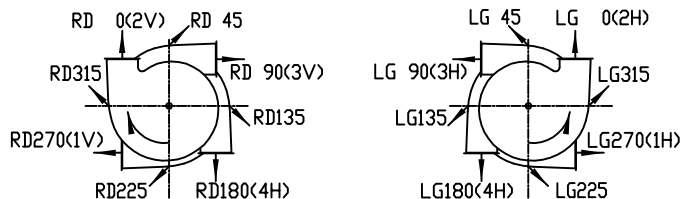

- ① FAN HOUSING.
Matl.:
- ② MOTOR and BEARING PEDESTAL.
Matl.:
- ③ FAN IMPELLER.
Matl: Salt and amoniaresistive aluminium alloy.
- ④ SHAFT SEAL OR GASTIGHT ASSEMBLY.
If Applicable
- ⑤ 2 OFF BALLBEARINGS, type
- ⑥ EL.MOTOR: Model:
kW: Rpm: V: Hz:
- ⑦ V-BELT TRANSMISSION, c/w Belt Guard

Date: 09/02-95

Revision: 01 4-1155

Drawn: R.Berge

N Y B O R G A S

N-6230 SYKKYLVEN - NORWAY

Tel: +47 70 25 40 80 - Fax +47 70 25 29 08

E-MAIL: office@nyborgfan.com - WEB: www.nyborgfan.com

HSV - B3



HIGH PRESSURE CENTR. FAN PERFORMANCE DATA

HSV 150 B
Imp: B9x450x25

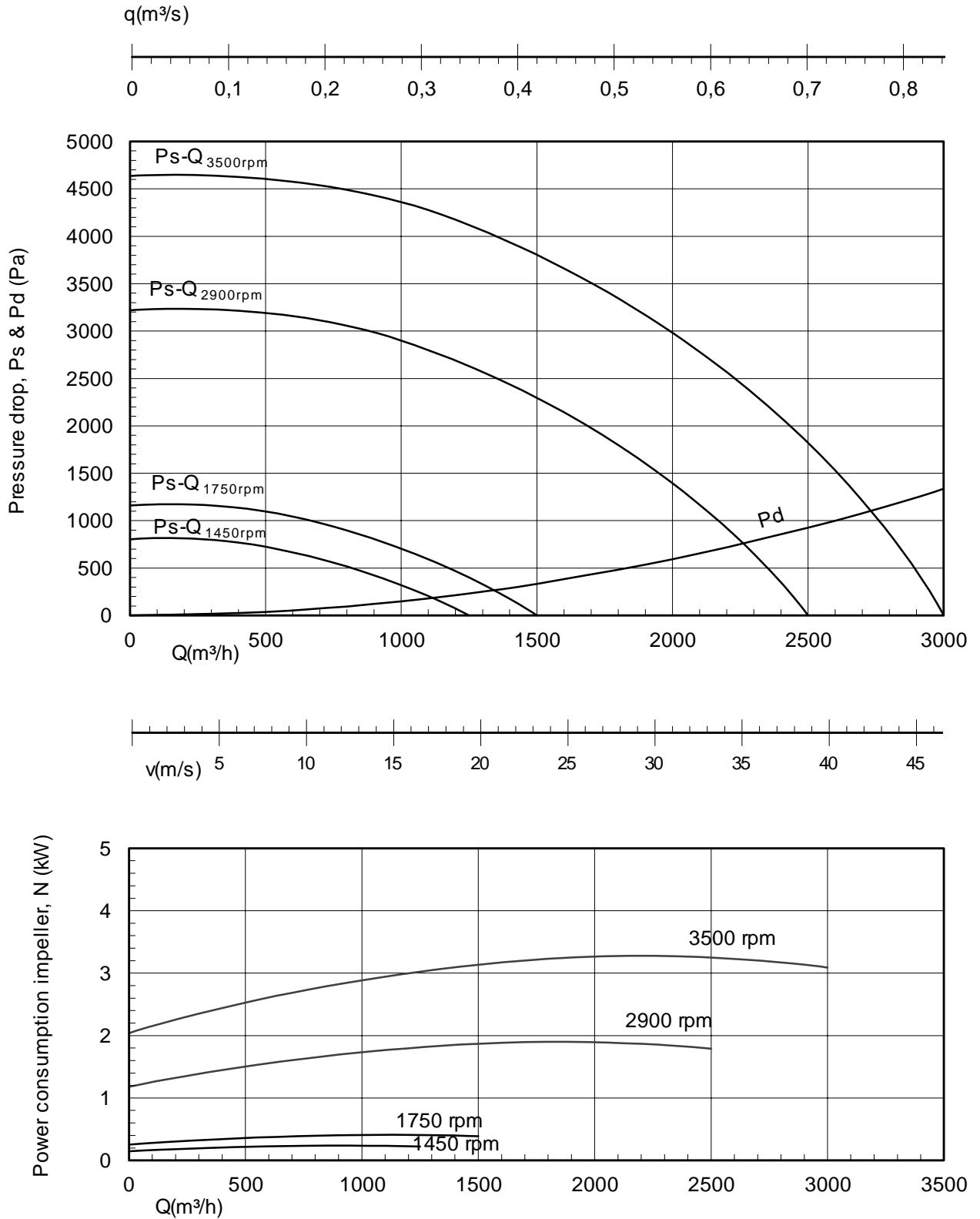

N Y B O R G A S

Hsv01-01

N-6230 SYKKYLVEN, NORWAY
TEL +47 70 25 40 80 - FAX +47 70 25 29 08
office@nyborgfan.com - www.nyborgfan.com

HSV 150 B



NYBORG HIGH PRESS. CENTR. FAN PERFORMANCE DATA

HSV 180 B
Imp: B9x450x50

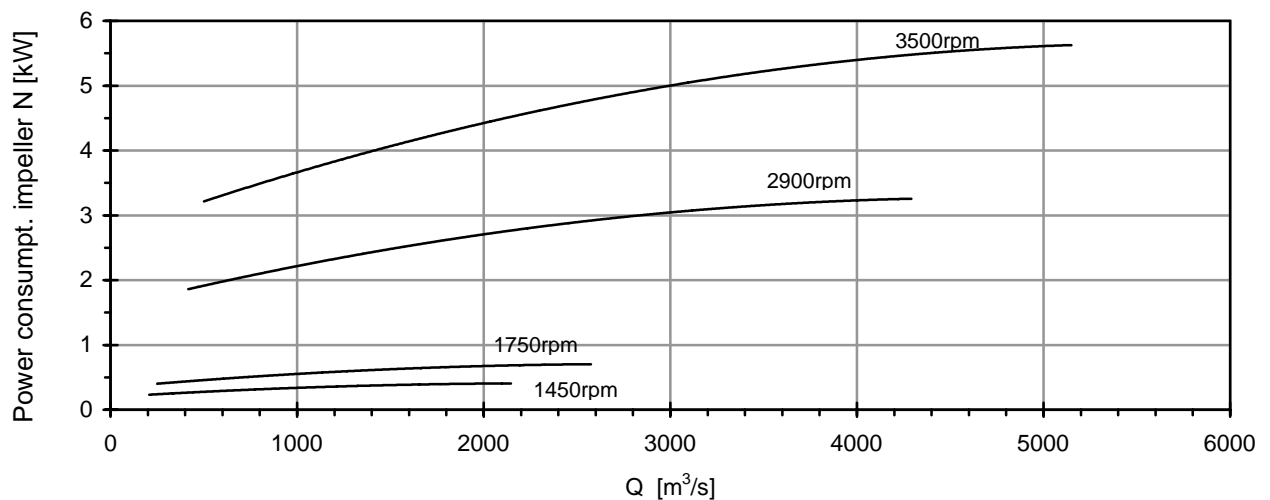
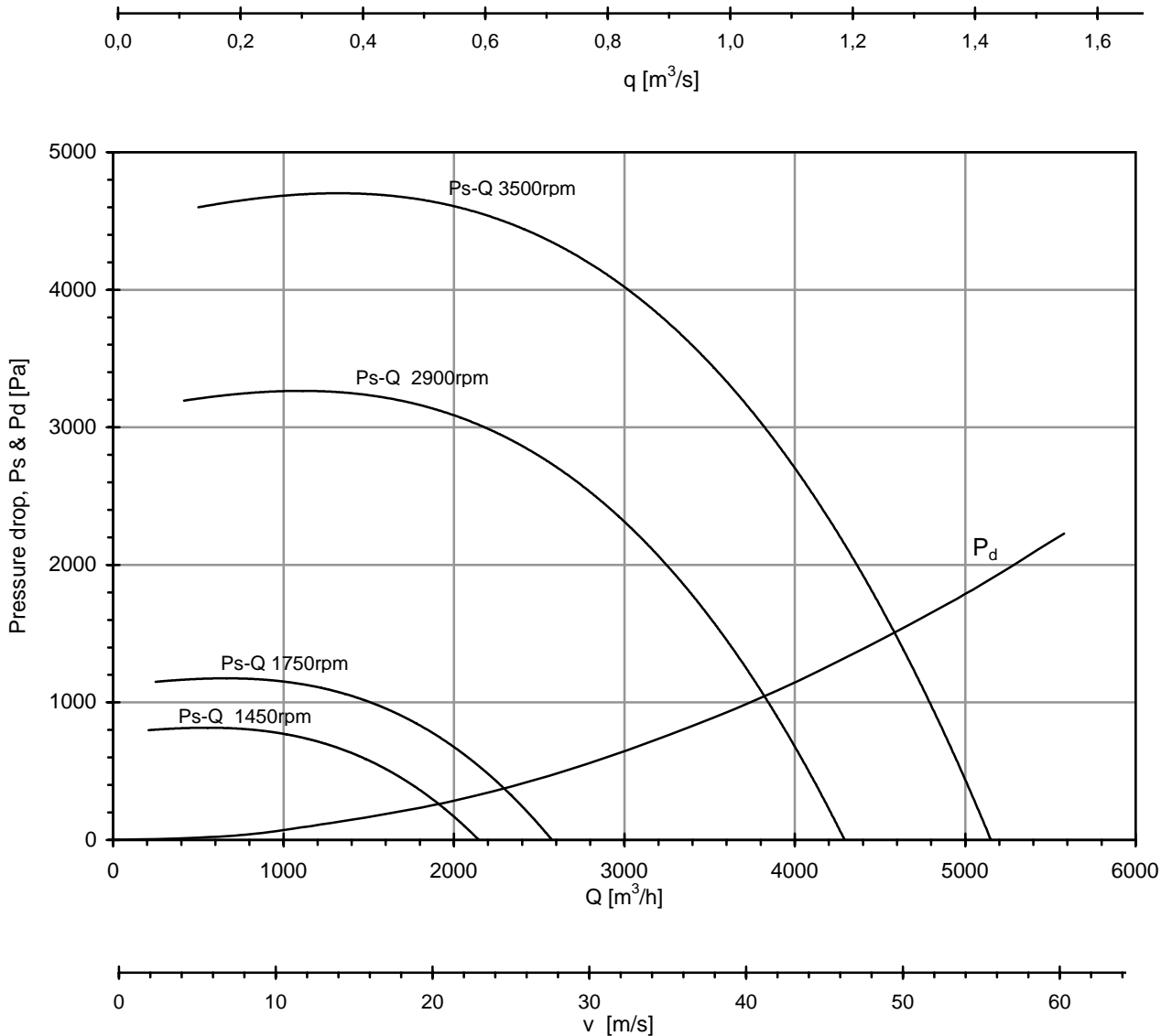

NYBORG AS

N-6230 Sykkylven, Norway
TEL +47 7025 4080 - FAX +47 7025 2908
office@nyborgfan.com - www.nyborgfan.com

hsv01_xls-7

HSV 180 B



NYBORG HIGH PRESS. CENTR. FAN PERFORMANCE DATA

HSV 180 B
Imp: B9x500x50

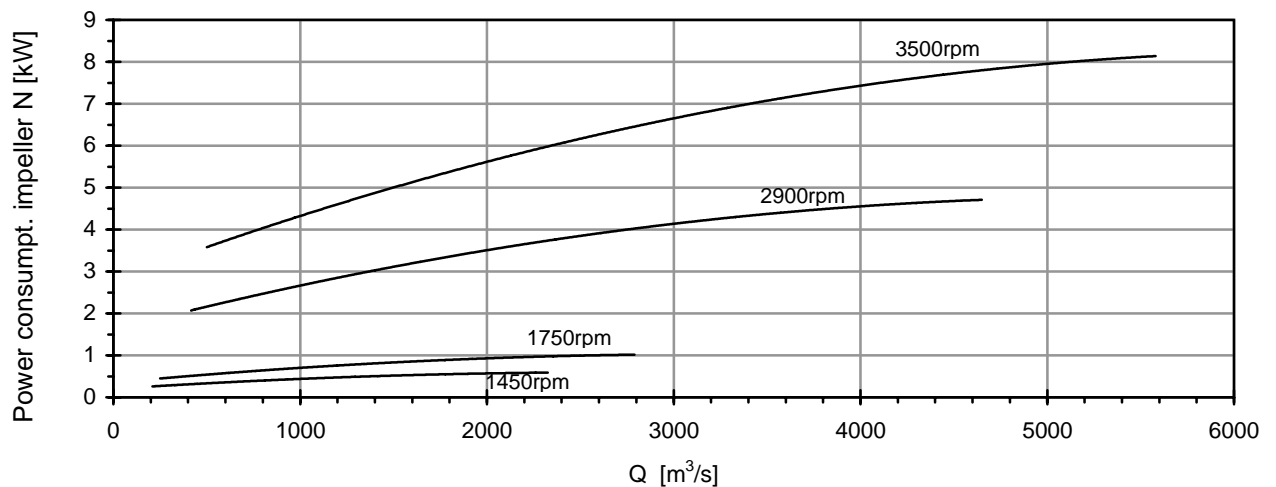
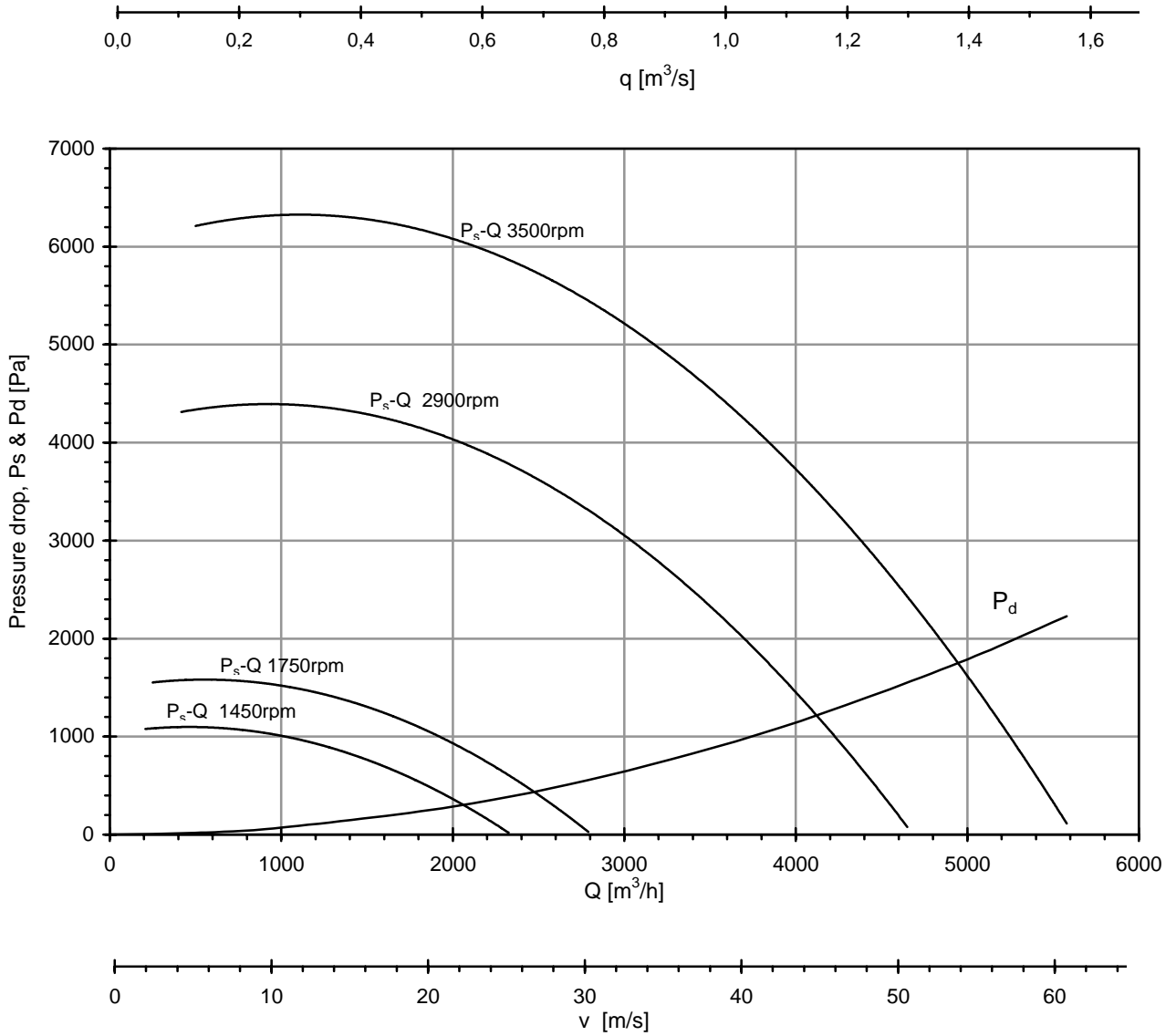

NYBORG AS

N-6230 Sykkylven, Norway
TEL +47 7025 4080 - FAX +47 7025 2908
office@nyborgfan.com - www.nyborgfan.com

hsv01_xls-6

HSV 180 B



HIGH PRESSURE CENTR. FAN PERFORMANCE DATA

HSV 210 B
Imp: B12x500x50

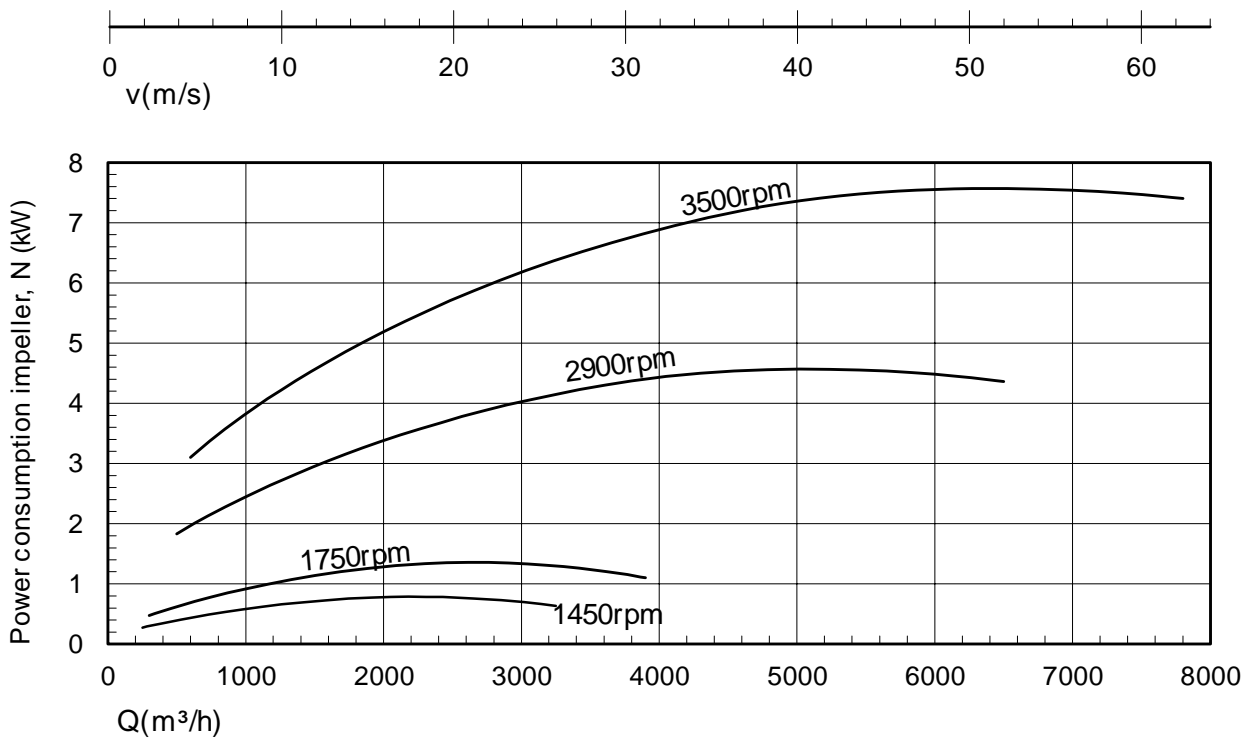
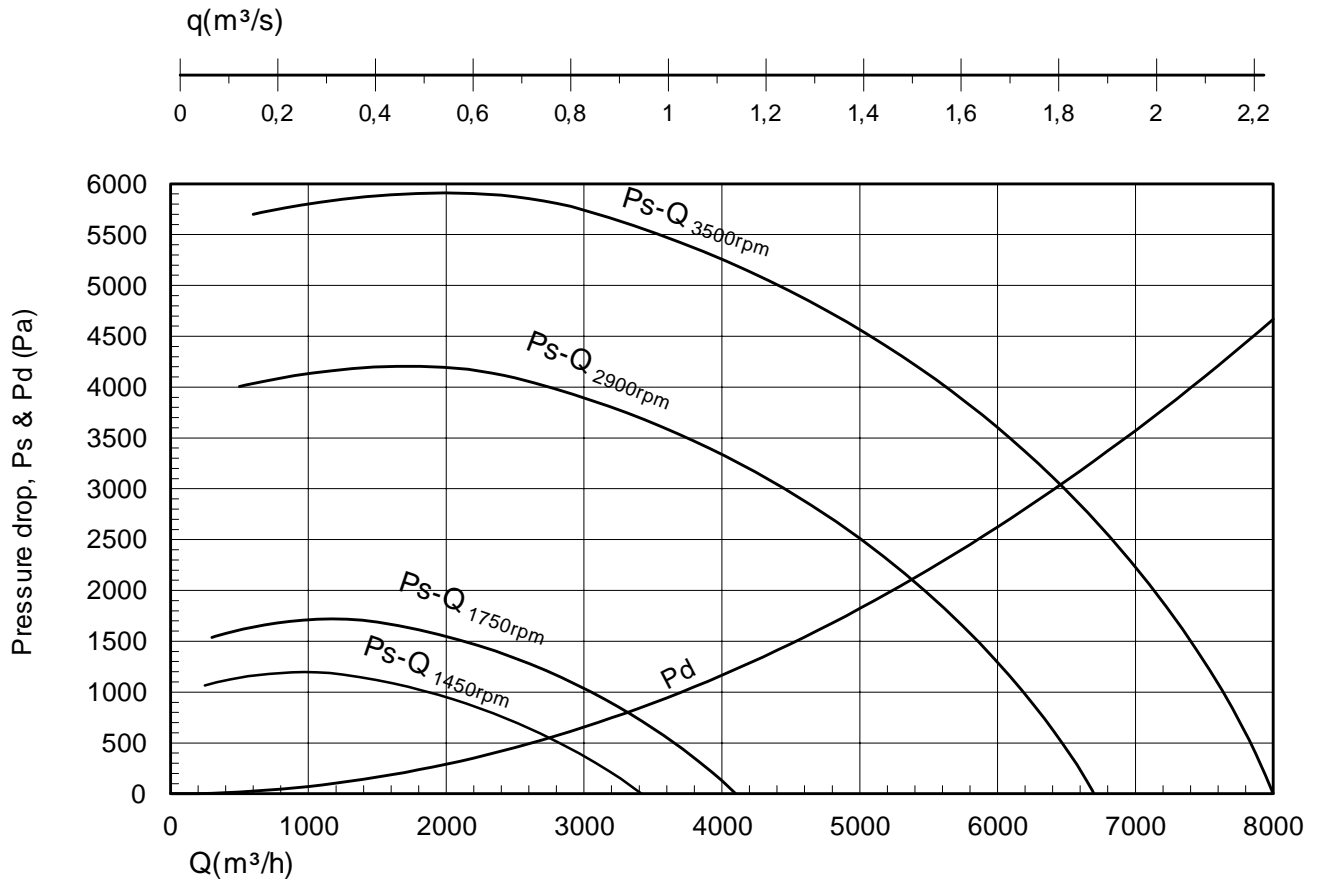

N Y B O R G A S

Hsv01-04

N-6230 SYKKYLVEN, NORWAY
TEL +47 70 25 40 80 - FAX +47 70 25 29 08
office@nyborgfan.com - www.nyborgfan.com

HSV 210 B



HIGH PRESSURE CENTR. FAN PERFORMANCE DATA

HSV 210 B
Imp: B12x550x50

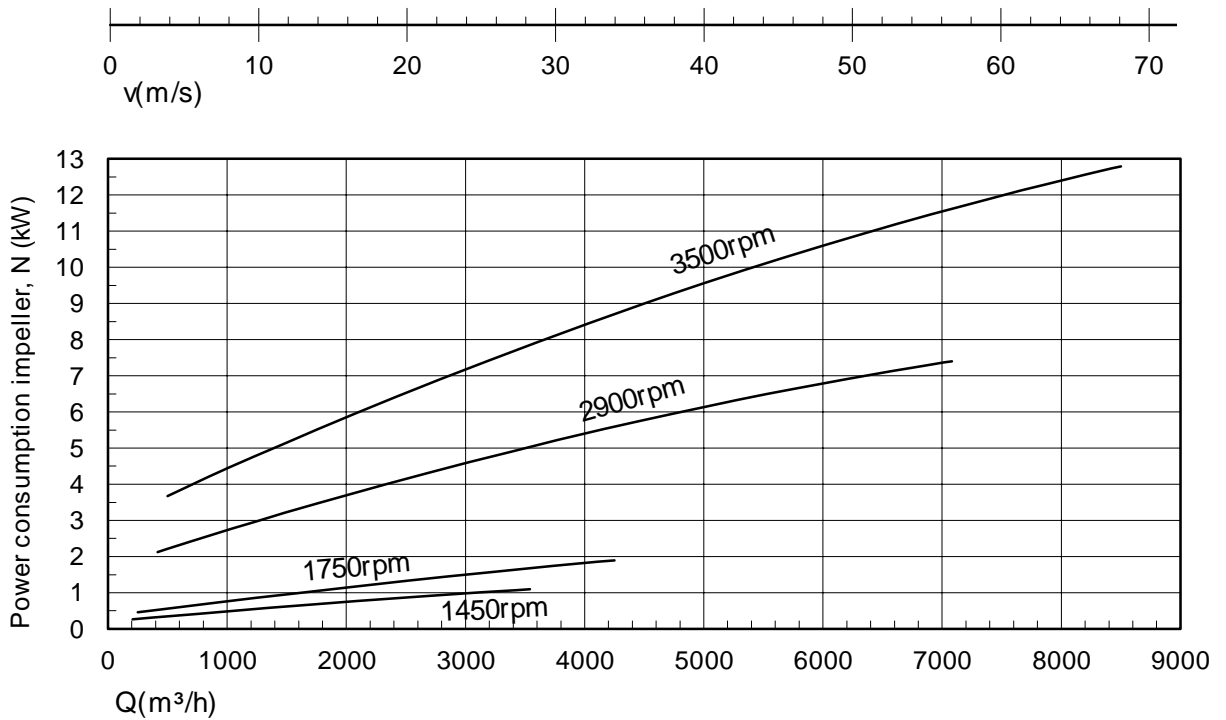
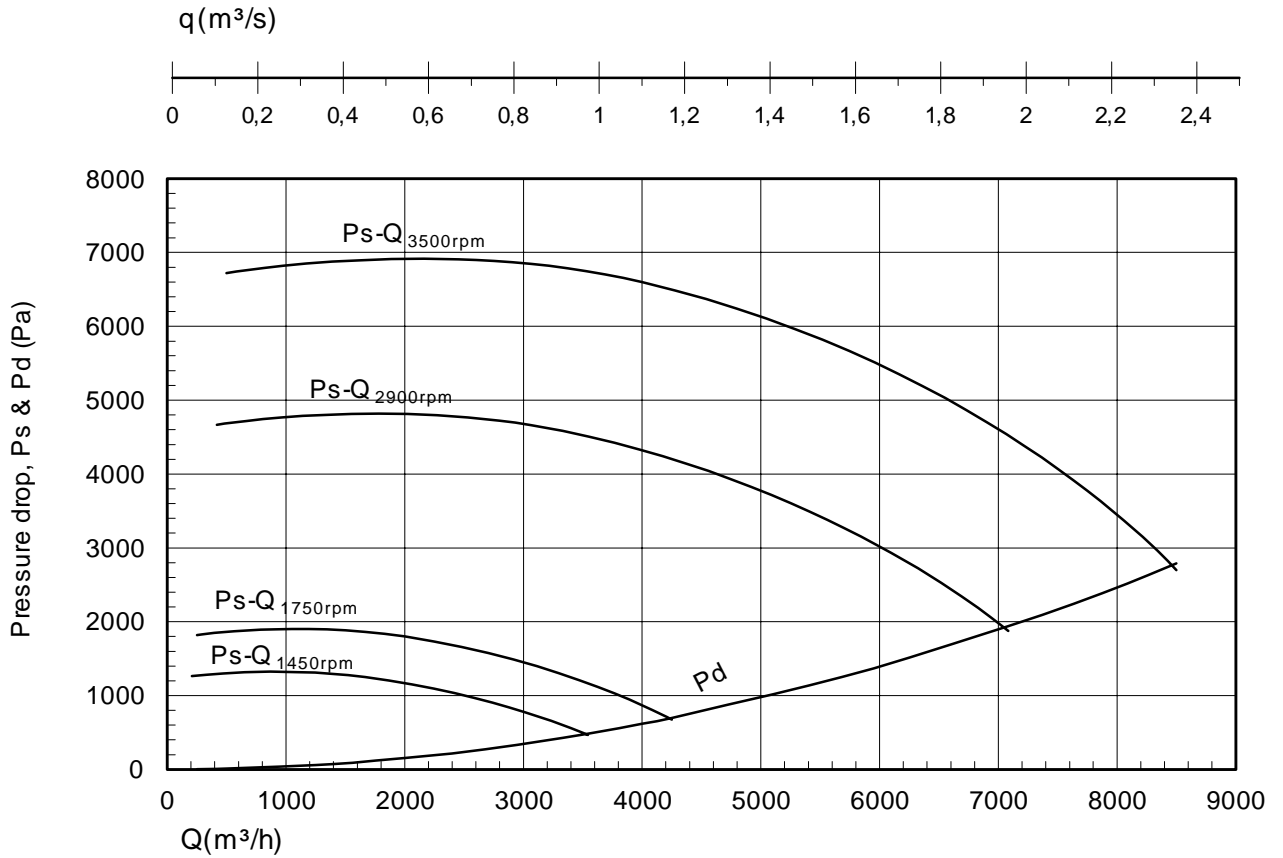

N Y B O R G A S

N-6230 SYKKYLVEN, NORWAY
TEL +47 70 25 40 80 - FAX +47 70 25 29 08
office@nyborgfan.com - www.nyborgfan.com

HSV 210 B



HIGH PRESSURE CENTR. FAN PERFORMANCE DATA

HSV 250 B
Imp: B12x620x70

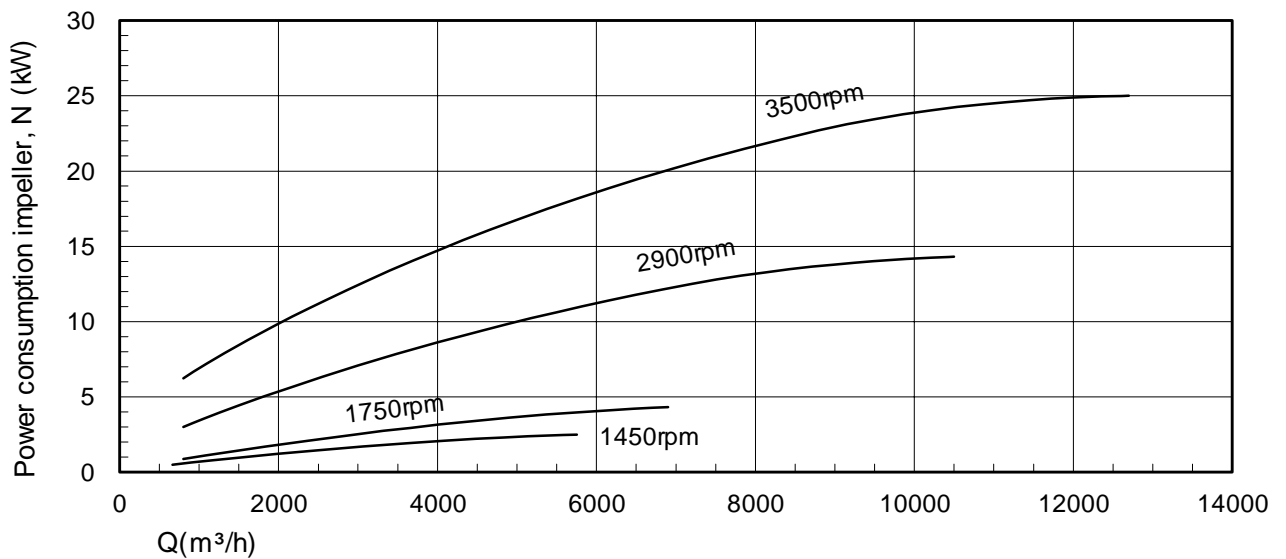
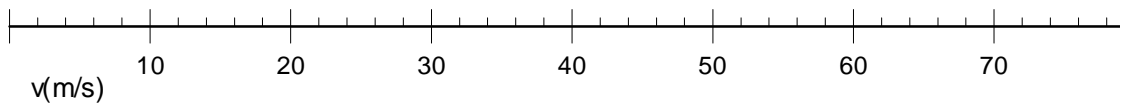
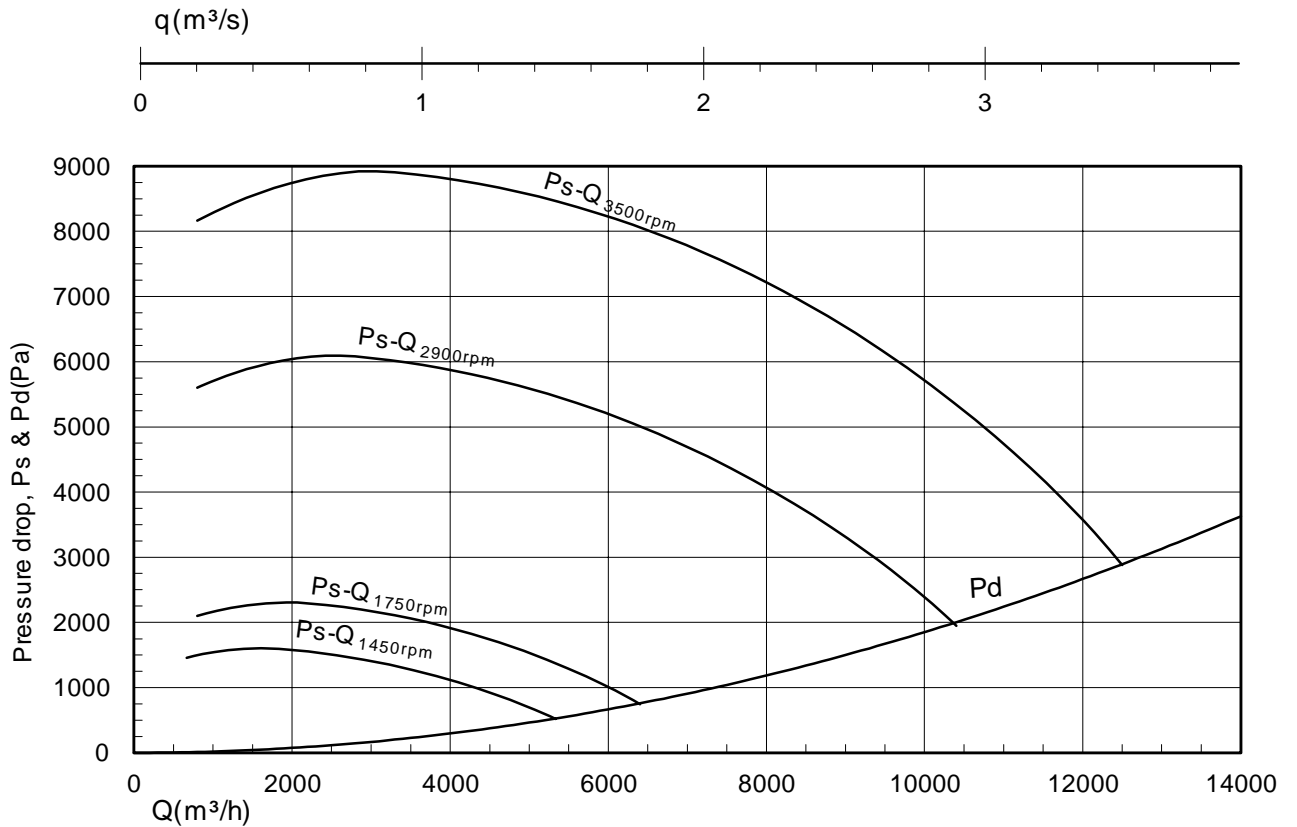

N Y B O R G A S

Hsv01-06

N-6230 SYKKYLVEN, NORWAY
TEL +47 70 25 40 80 - FAX +47 70 25 29 08
office@nyborgfan.com - www.nyborgfan.com

HSV 250 B



HIGH PRESSURE CENTR. FAN PERFORMANCE DATA

HSV 300 B
Imp: B9x650x75

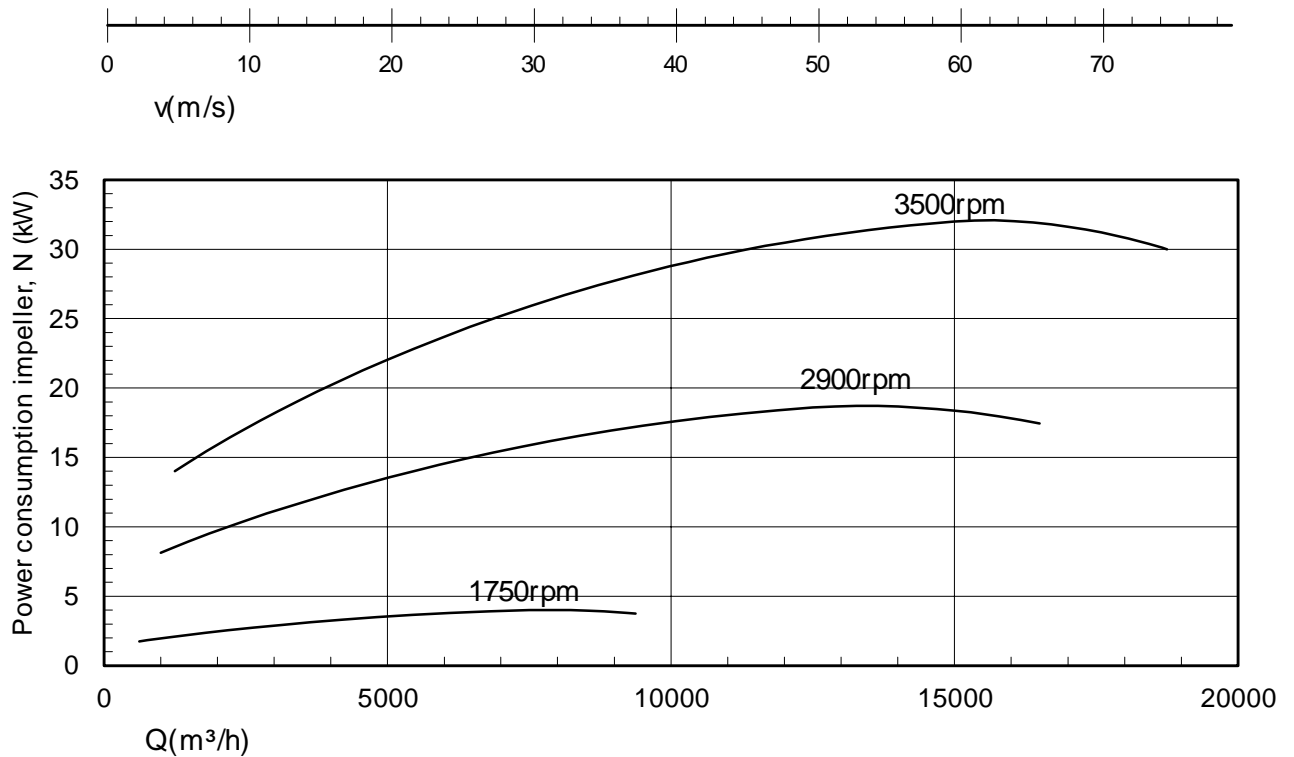
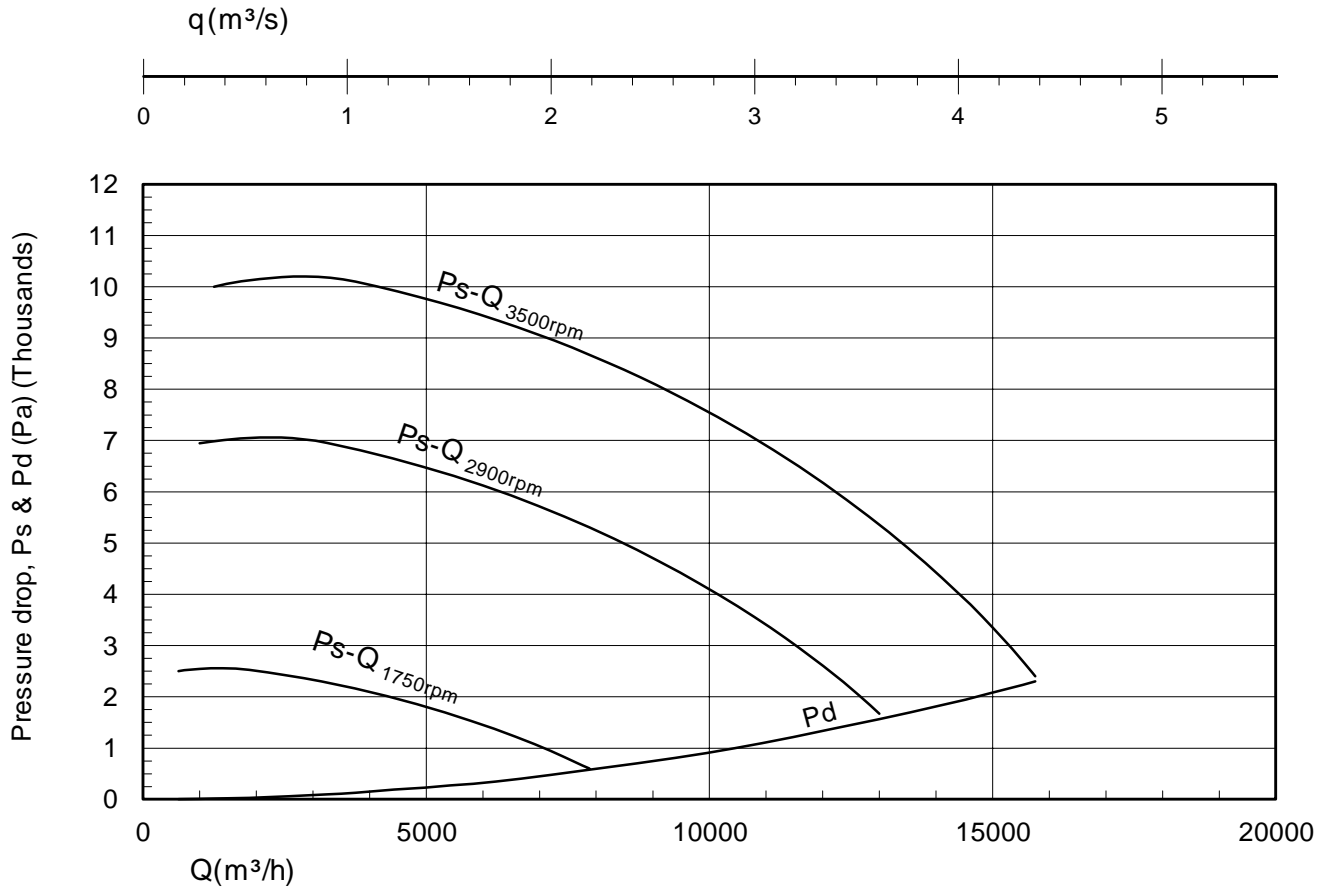

N Y B O R G A S

hsv01-07

N-6230 SYKKYLVEN, NORWAY
TEL +47 70 25 40 80 - FAX +47 70 25 29 08
office@nyborgfan.com - www.nyborgfan.com

HSV 300 B



HIGH PRESSURE CENTR. FAN PERFORMANCE DATA

HSV 300 B
Imp: B9x720x75

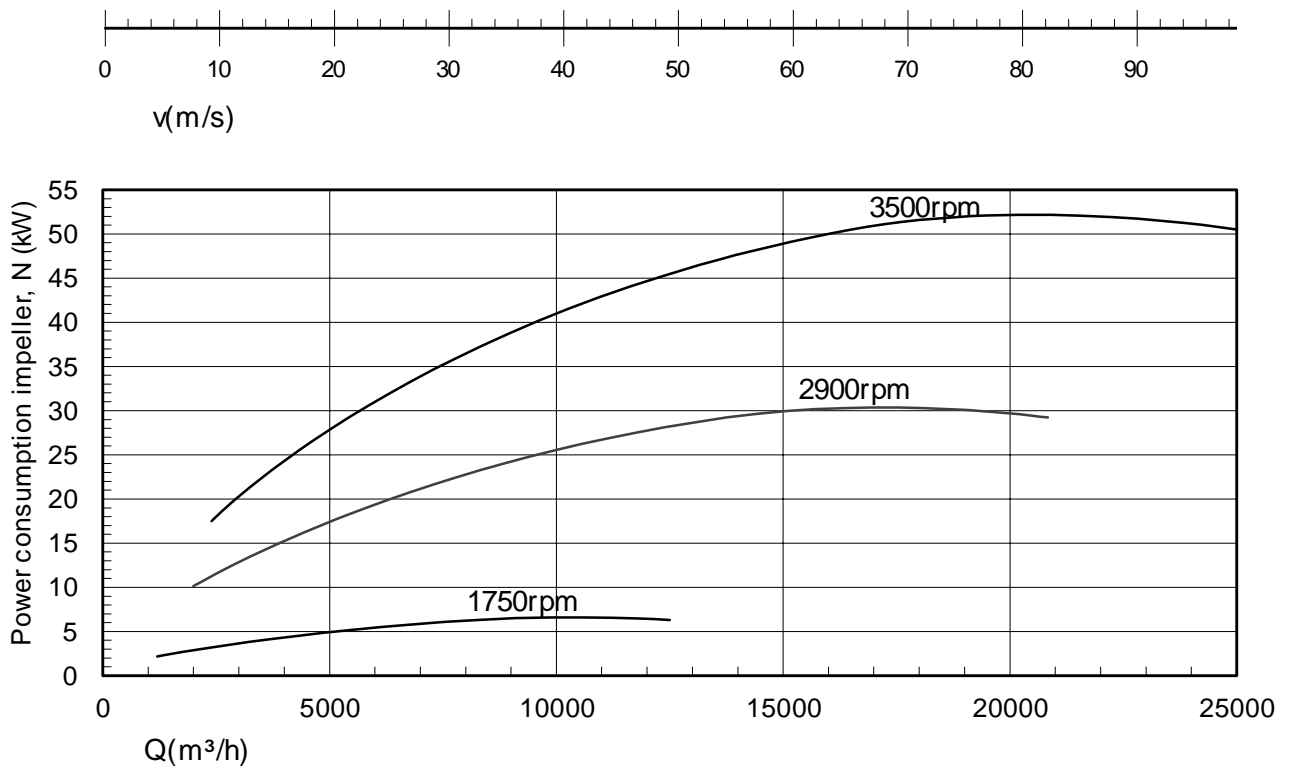
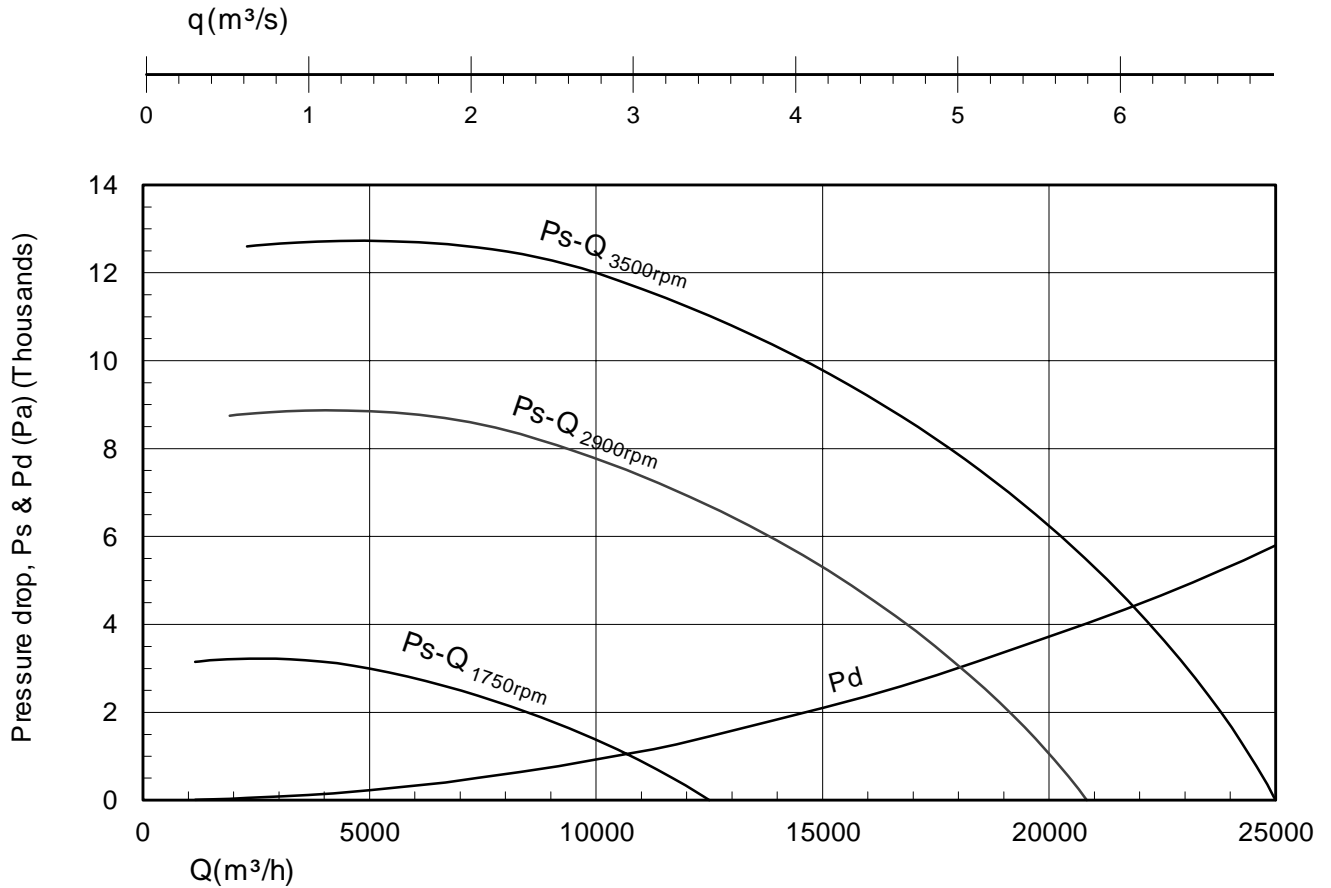

N Y B O R G A S

N-6230 SYKKYLVEN, NORWAY
TEL +47 70 25 40 80 - FAX +47 70 25 29 08
office@nyborgfan.com - www.nyborgfan.com

HSV 300 B

Hsv01-17



HIGH PRESSURE CENTR. FAN PERFORMANCE DATA

HSV 350 B
Imp: B9x700x80

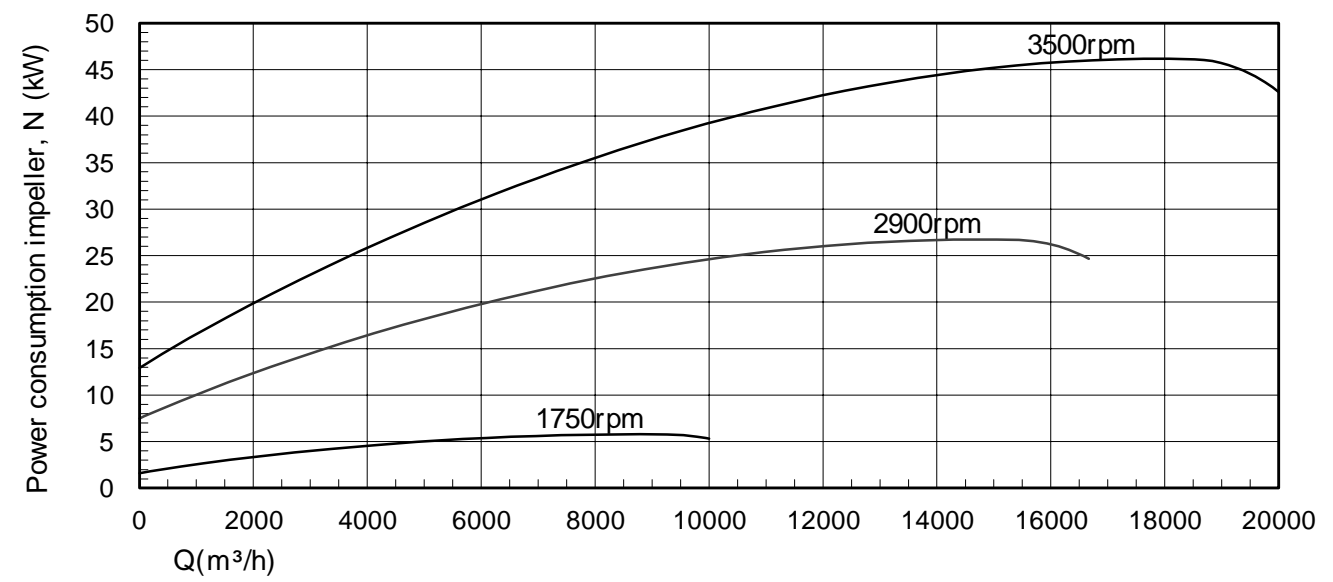
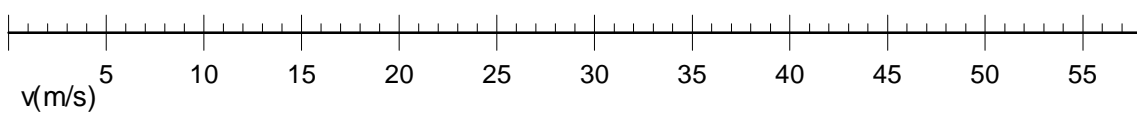
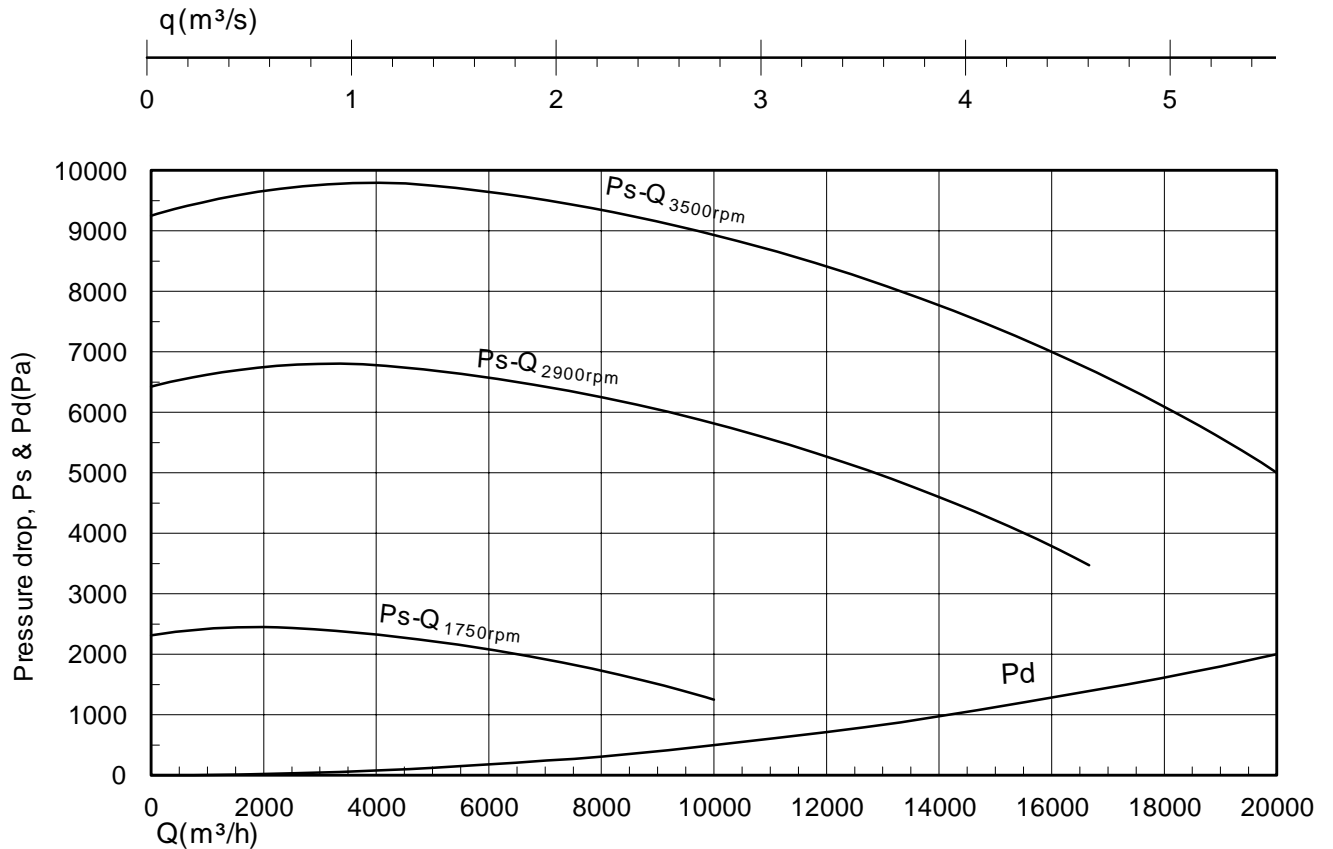

N Y B O R G A S

N-6230 SYKKYLVEN, NORWAY
TEL +47 70 25 40 80 - FAX +47 70 25 29 08
office@nyborgfan.com - www.nyborgfan.com

HSV 350 B

hsv01-09



HIGH PRESSURE CENTR. FAN PERFORMANCE DATA

HSV 400 B
Imp: B9x800x95

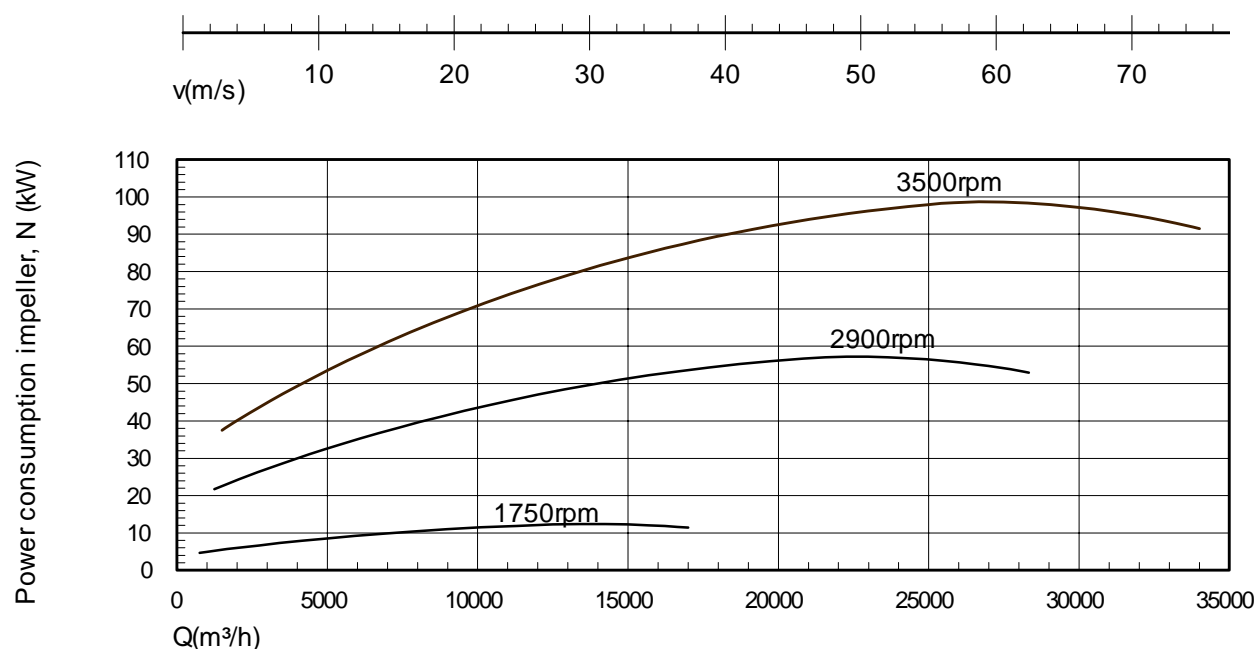
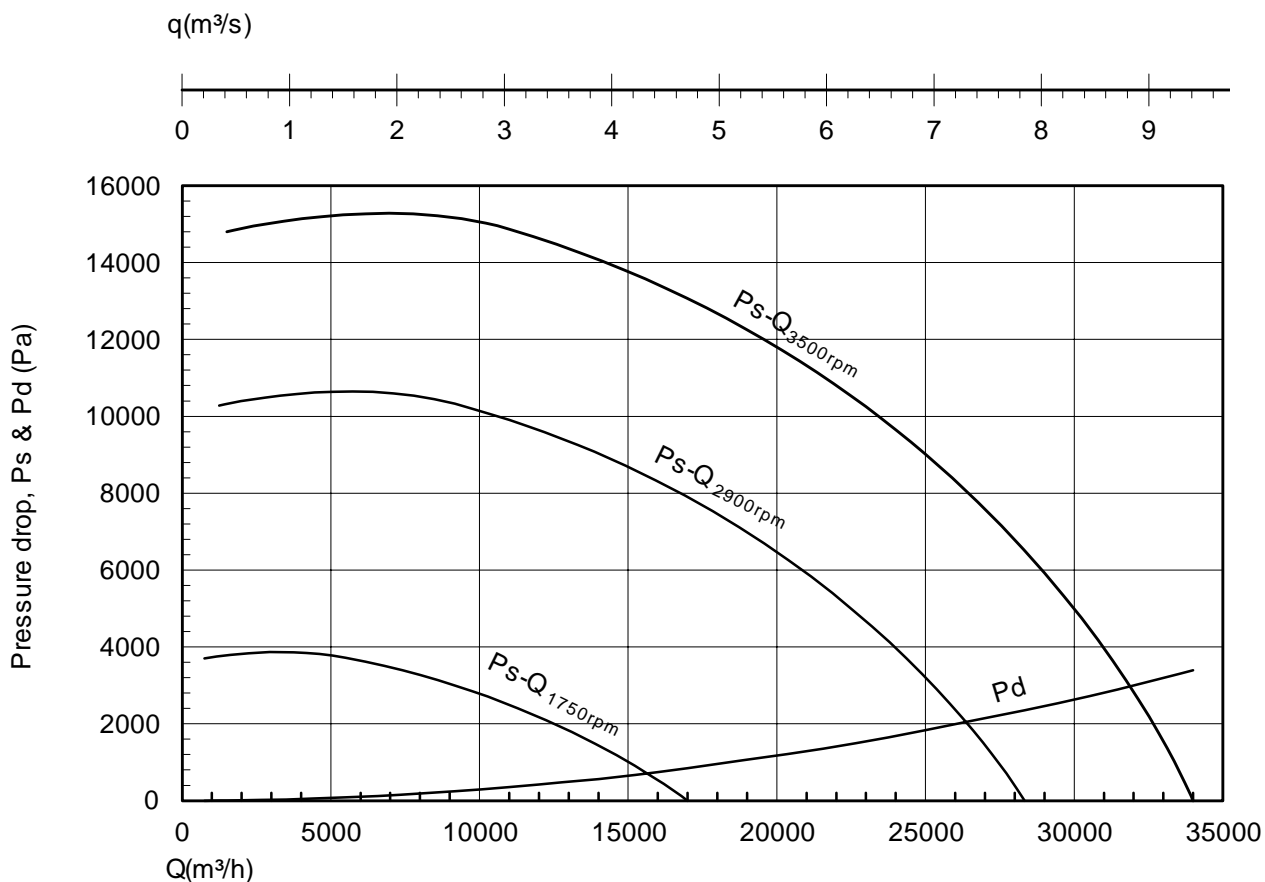

N Y B O R G A S

HSV.PRS-11

N-6230 SYKKYLVEN, NORWAY
TEL +47 70 25 40 80 - FAX +47 70 25 29 08
E-mail : office@nyborgfan.com - www.nyborgfan.com

HSV 400 B



HIGH PRESSURE CENTR. FAN PERFORMANCE DATA

HSV 400 B
Imp: B9x830x95

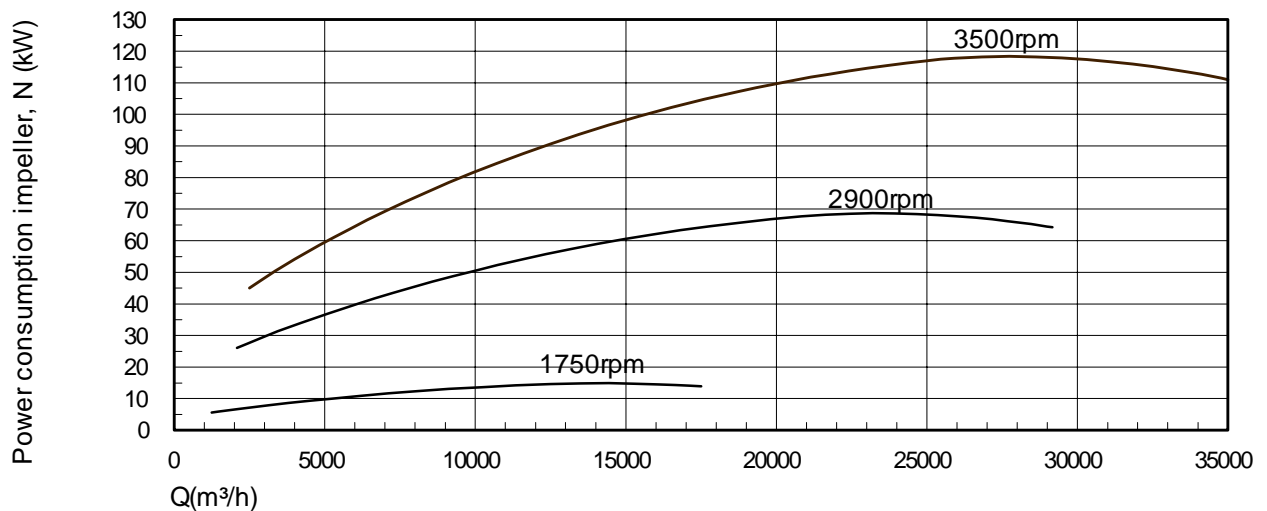
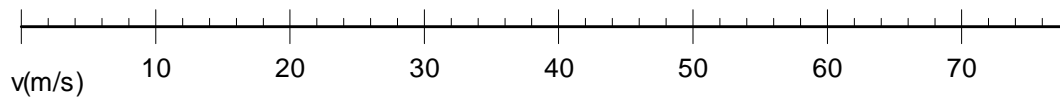
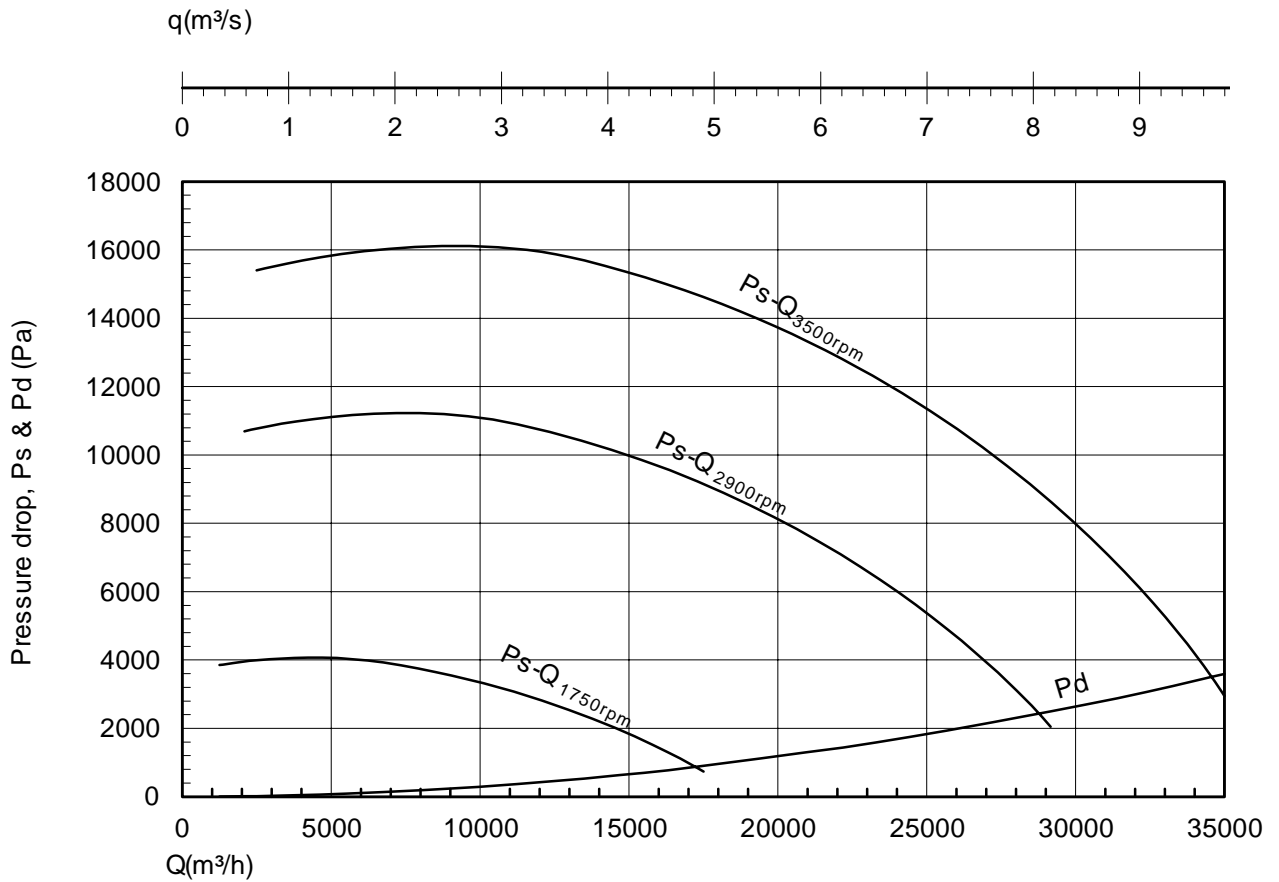

N Y B O R G A S

hsv01-10

N-6230 SYKKYLVEN, NORWAY
TEL +47 70 25 40 80 - FAX +47 70 25 29 08
E-mail : office@nyborgfan.com - www.nyborgfan.com

HSV 400 B



HIGH PRESSURE CENTR. FAN PERFORMANCE DATA

HSV 450 B
Imp: B12x1000x95

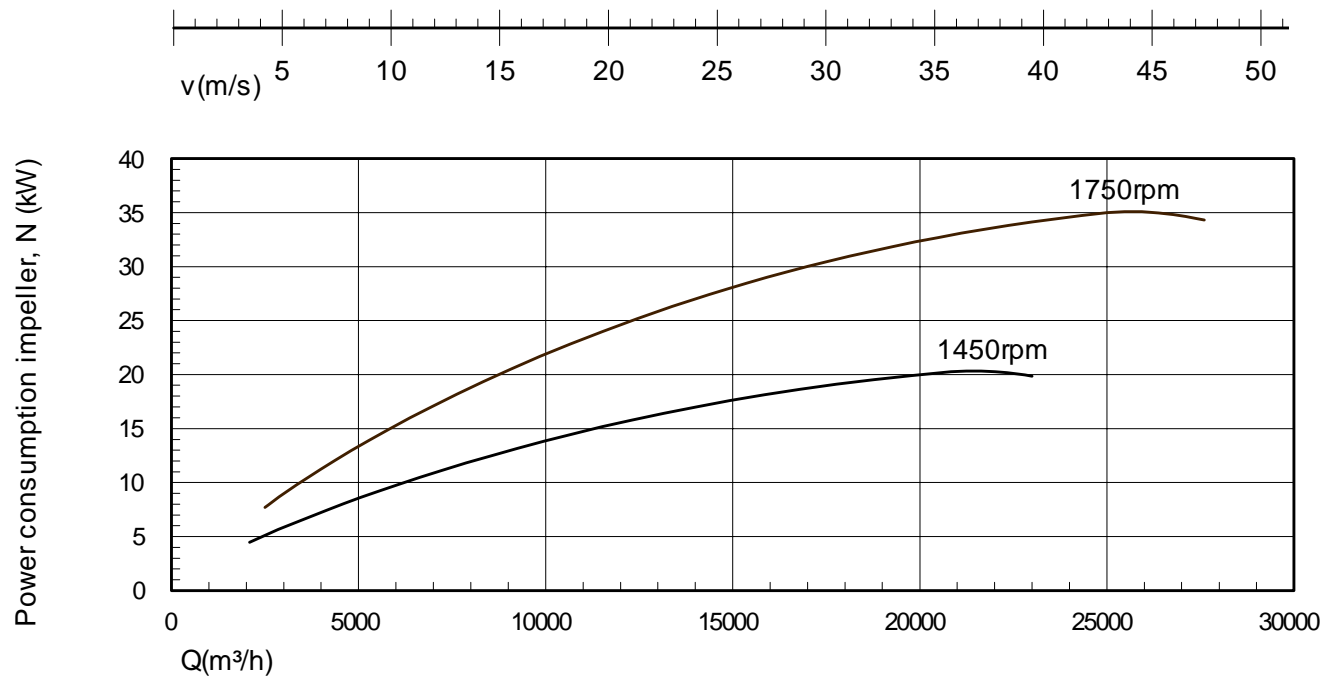
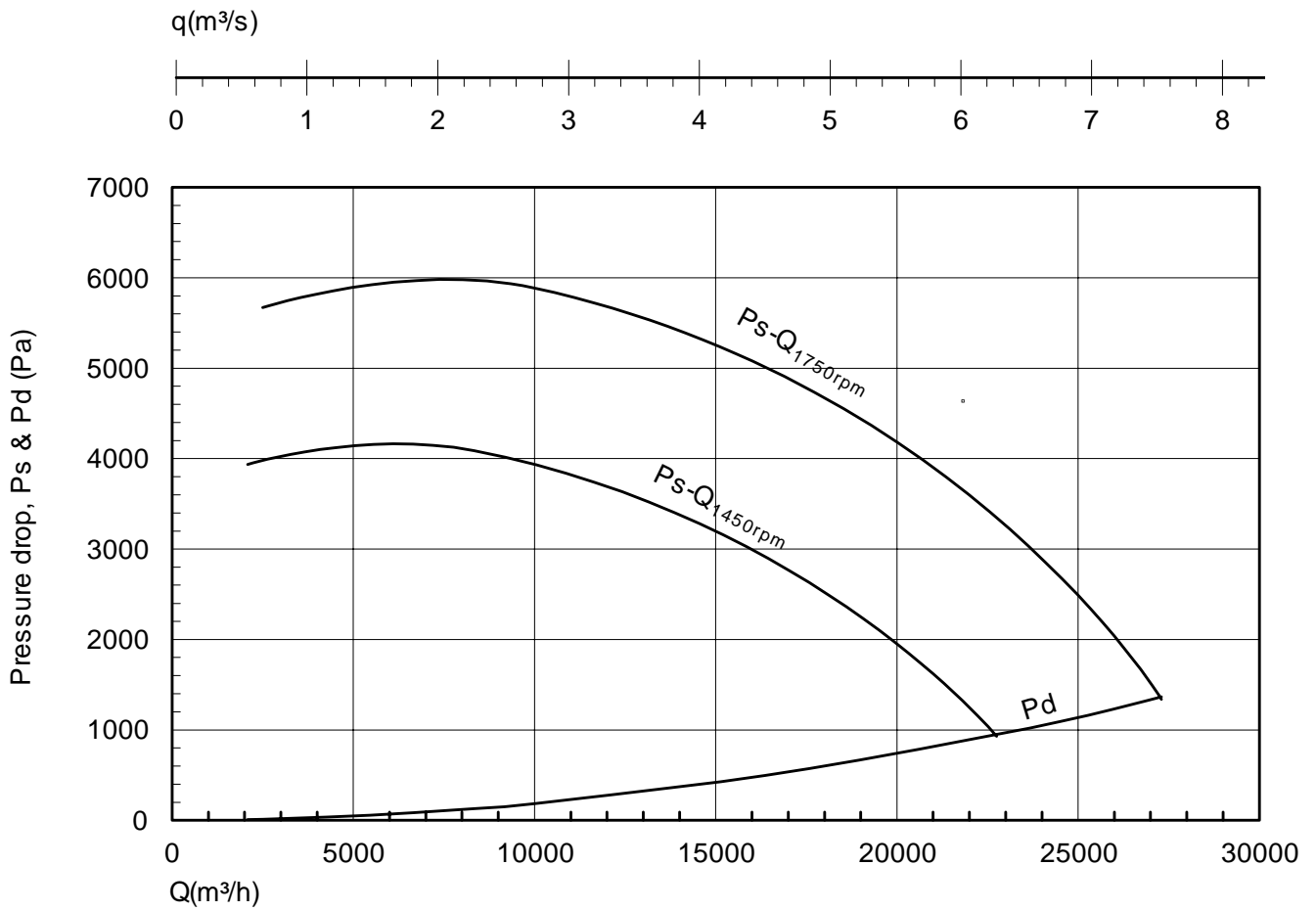

N Y B O R G A S

hsv01-12

N-6230 SYKKYLVEN, NORWAY
TEL +47 70 25 40 80 - FAX +47 70 25 29 08
office@nyborgfan.com - www.nyborgfan.com

HSV 450 B



HIGH PRESSURE CENTR. FAN PERFORMANCE DATA

HSV 500 B
Imp: B12x1100x125

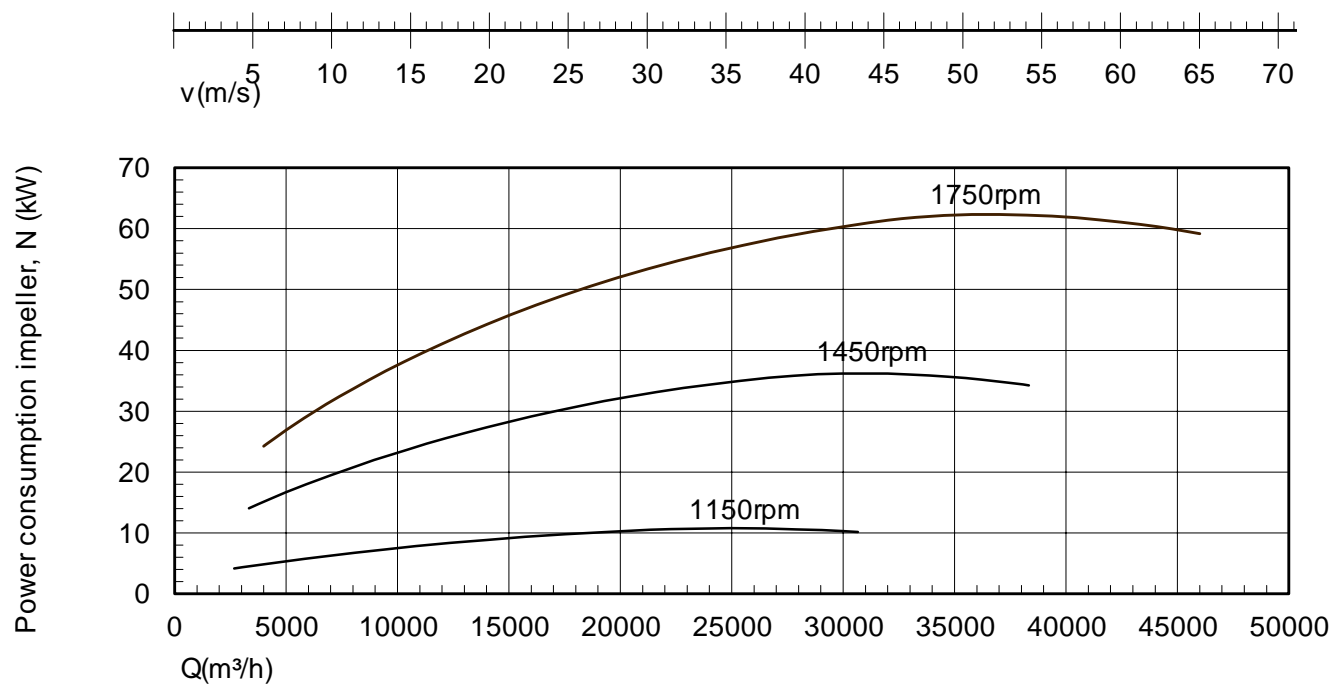
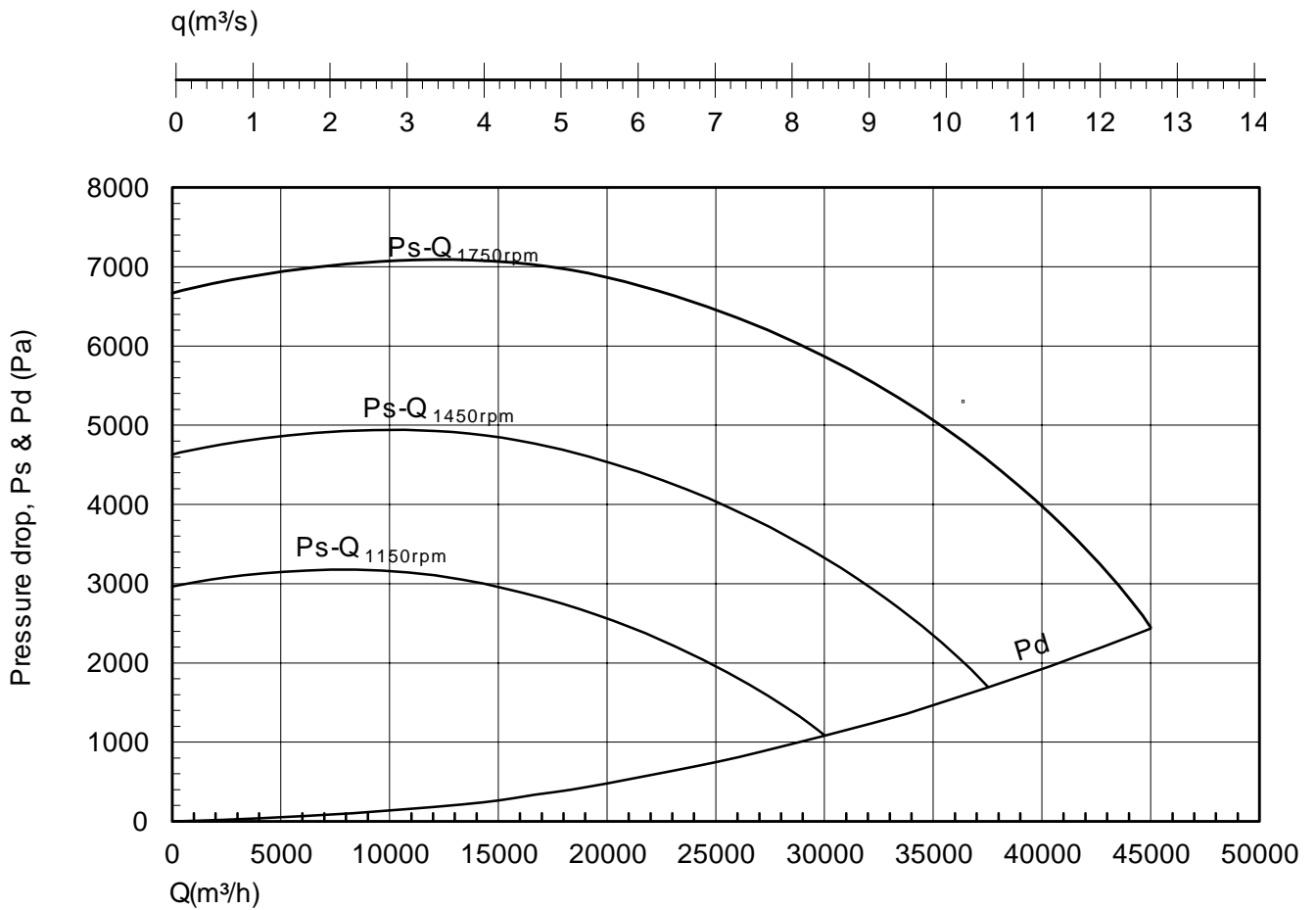

N Y B O R G A S

hsv01-13

N-6230 SYKKYLVEN, NORWAY
TEL +47 70 25 40 80 - FAX +47 70 25 29 08
office@nyborgfan.com - www.nyborgfan.com

HSV 500 B



HIGH PRESSURE CENTR. FAN PERFORMANCE DATA

HRV 250 B
Imp: B9x720x35

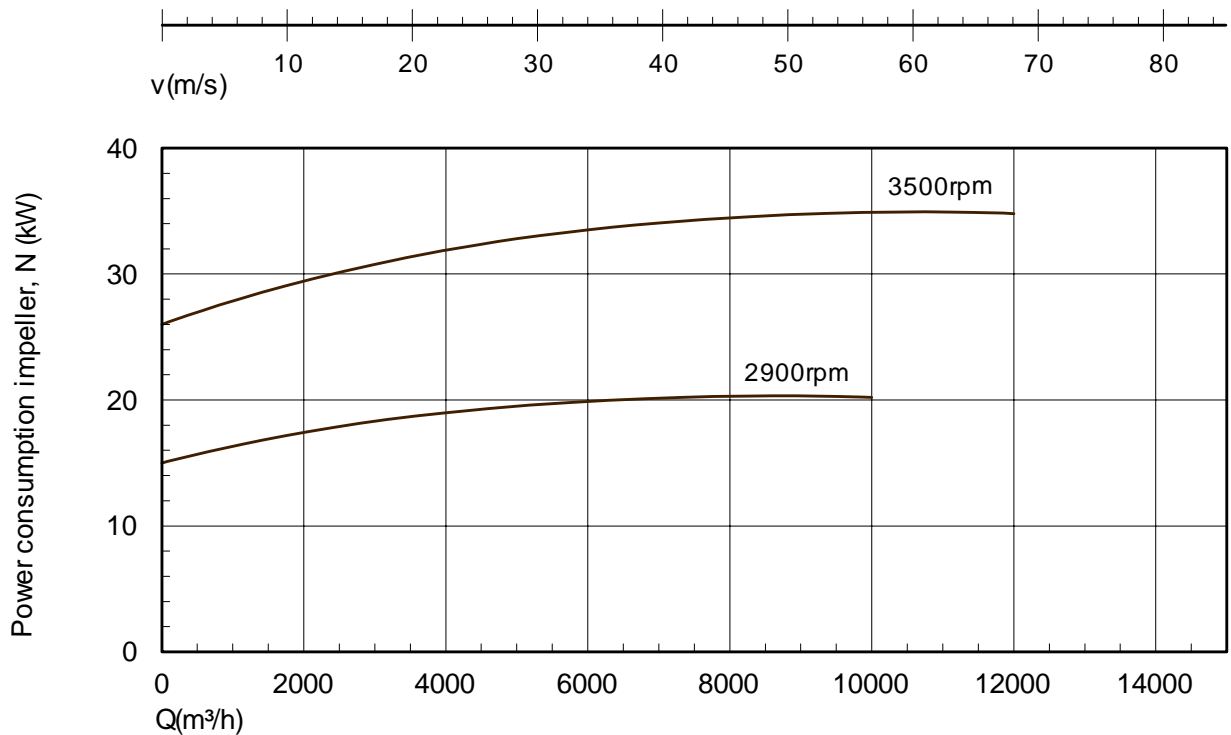
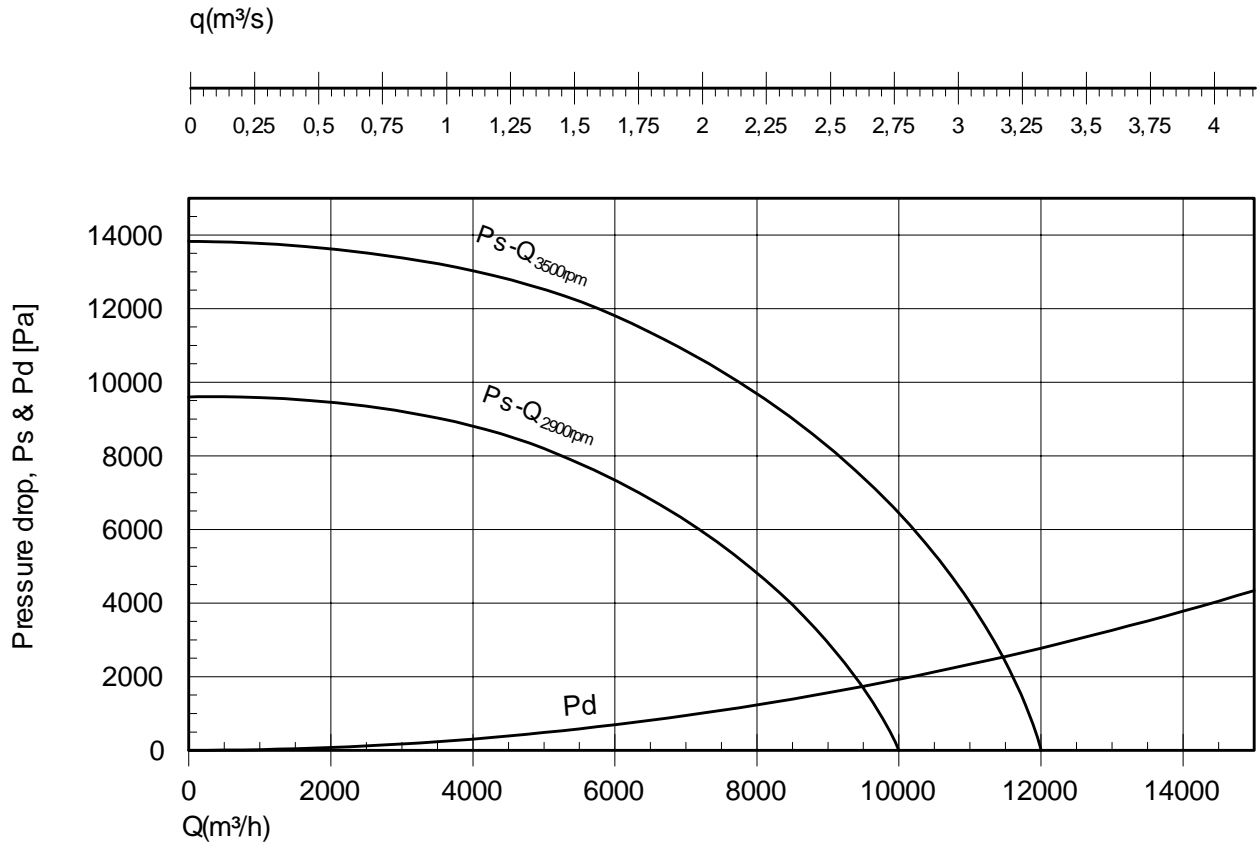

N Y B O R G A S

hrv2-2

N-6230 SYKKYLVEN, NORWAY
TEL +47 70 25 40 80 - FAX +47 70 25 29 08
office@nyborgfan.com - www.nyborgfan.com

HRV 250 B



NYBORG HIGH PRESS. CENTR. FAN PERFORMANCE DATA

HRV 300 B

Imp: B9x975x35

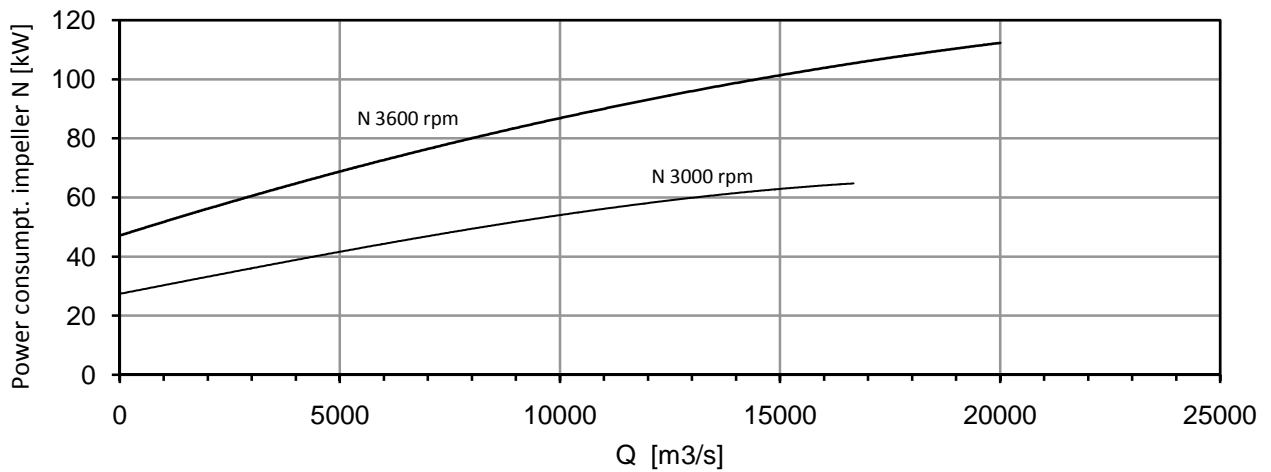
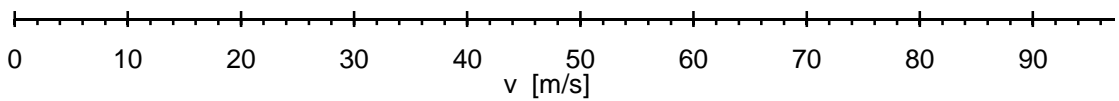
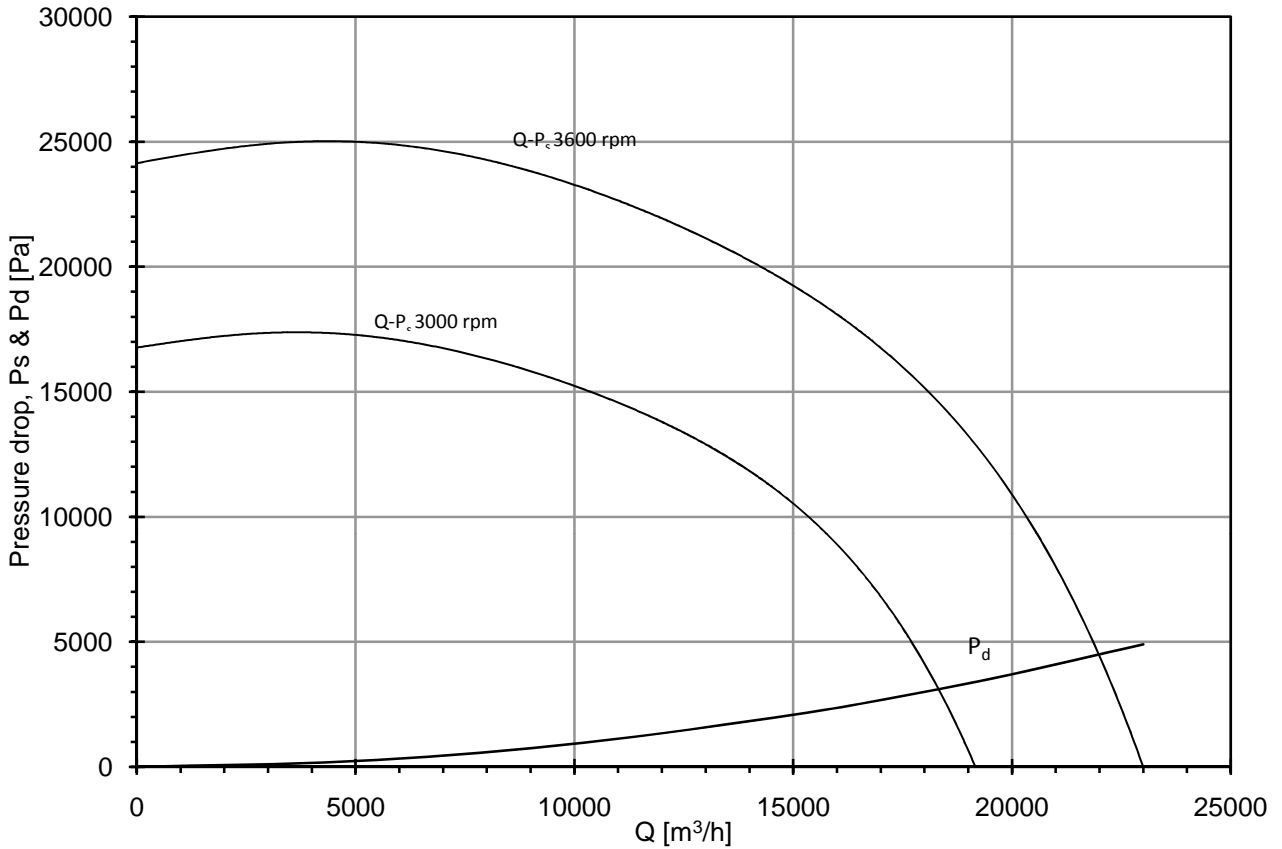
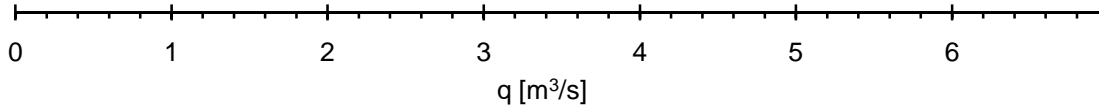

NYBORG AS

N-6230 Sykkylven, Norway

TEL +47 7025 4080 - FAX +47 7025 2908

office@nyborgfan.com - www.nyborgfan.com

hsv01_xls-10
18.02.2009-omk

HRV 300 B