

APPLICATIONS

Typical application for this fan is mechanical ventilation of hazardous zones and cargo tanks onboard ships. To be mounted into tank openings on deck.

DESIGN

The MPV-A1EGSX is designed primarily for mechanical ventilation of cargo tanks and other places where explosive fumes occur. The fan is spark proof with a water driven or compressed air driven motor.

EXECUTION

Fan casing consists of sea water resistant aluminium in a heavy-duty design. The propeller is made of salt- and ammonia resistant aluminium or reinforced polypropylene. Aerodynamically shaped and balanced. The wire mesh guard is made of stainless steel.

The MPV-A1EGSX can be delivered in the range from size no 300 to size no 500. PCD diameter can be adjusted to suit customers' requirements.

MOTOR

Seawater or compressed air driven.

CLASSIFICATION SOCIETIES

The fan satisfies the demands of the various classification societies.

ACCESSORIES (water driven fan)

- Trolley
- Waterhoses inlet/outlet
- Collapsible air duct

ACCESSORIES (air driven fan)

- Trolley
- Air hose, drive air
- Air filter / oiler
- Collapsible air duct



PORTABLE GAS FREEING FAN

MPV - A1EGSX

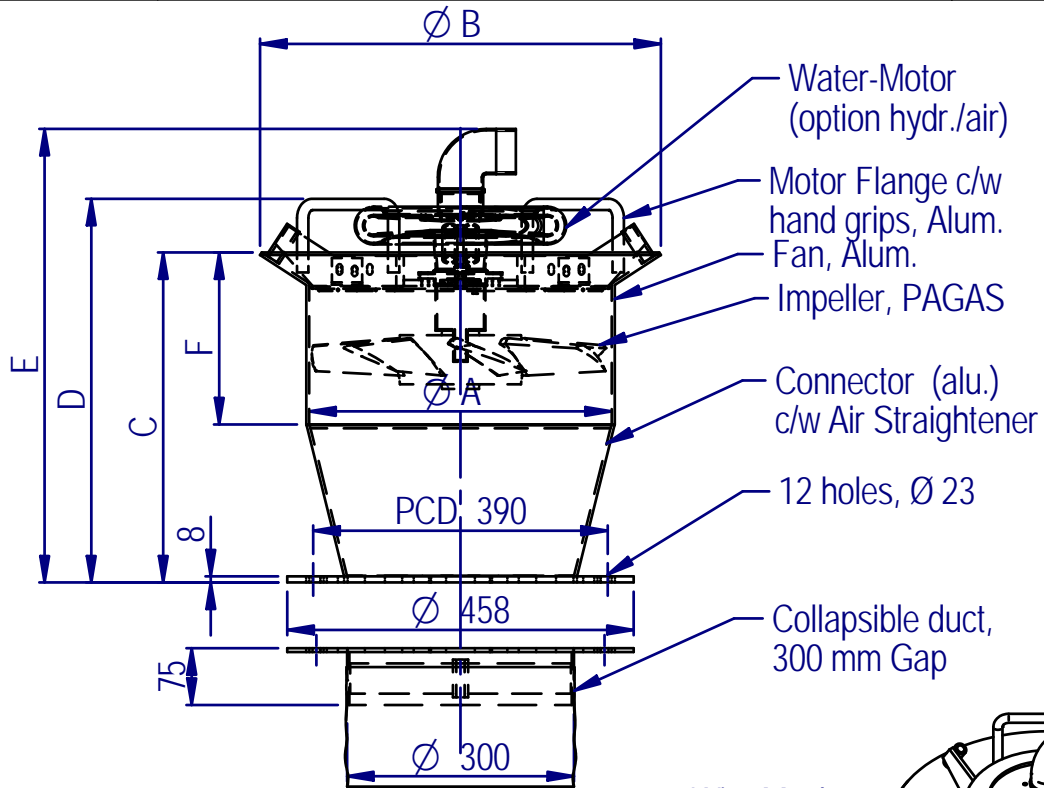

- Water-Motor (option hydr./air)
- Motor Flange c/w hand grips, Alum. Fan, Alum.
- Impeller, PAGAS
- Connector (alu.) c/w Air Straightener
- 12 holes, Ø 23
- Collapsible duct, 300 mm Gap

Wire Mesh, AISI 316L

	MPV 350	MPV 400	MPV 450	MPV 500	Trolley (option)	Air Motor (option)	Flexible Duct incl. adaptor (option)
A	355	400	450	500			
B	470	530	580	620			
C	436	436	436	459			
D	514	514	514	537			
E	610	610	610	630			
F	225	225	225	240			
Weight	25 kg	26 kg	27 kg	28 kg	11,5 kg	+ 1 kg	5 kg

4-2158

N Y B O R G A S

R.Berge
12/09-03,
rev02: 18/12-07
rev03: 04/03-16

N-6230 SYKKYLVEN, NORWAY
TEL +47 70 25 40 80 - FAX +47 70 25 29 08
office@nyborgfan.com - www.nyborgfan.com

MPV - A1EGSX



PORTABLE GAS-FREEING FAN
ARRANGEMENT HOSES, PRINCIPLE SKETCH

MPV 300/450
A1EGSX

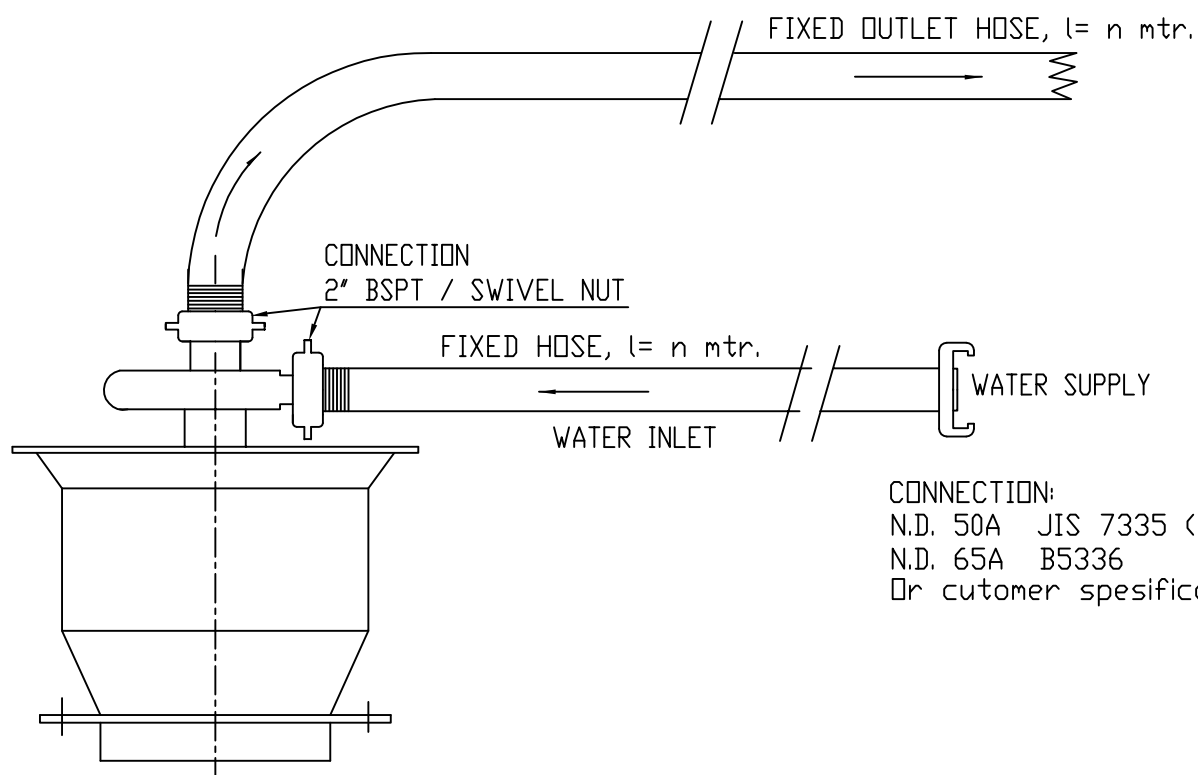

Date : 05.03.98

Tegn : 4-1324

Name : M.Berge

N Y B O R G A S

N-6230 SYKKYLVEN - NORWAY

Tel: +47 70 25 40 80 - Fax +47 70 25 29 08

E-MAIL: office@nyborgfan.com - WEB: www.nyborgfan.com

MPV 300/450
A1EGSX



WATER INLET HOSE

MPV 300/450
A1EGSX

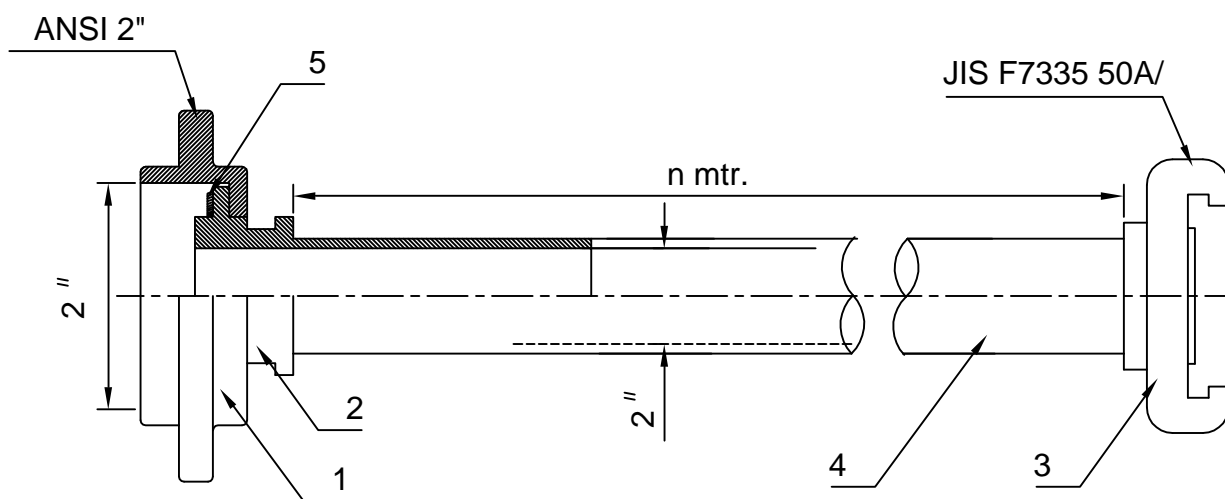

5	1	Packing	Neopr
4	1	Hose, Armtex	
3	1	Nakajima joint	Brass
2	2	Hose nipple	Brass
1	1	Swivel nut	Brass
Item	Qty	Part/Description	Matr.

Date : 05.03.98

Tegn : 4-1327

Name : M.Berge

N Y B O R G A S

N-6230 SYKKYLVEN - NORWAY

Tel: +47 70 25 40 80 - Fax +47 70 25 29 08

E-MAIL: office@nyborgfan.com - WEB: www.nyborgfan.com

MPV 300/450
A1EGSX



WATER OUTLET HOSE

MPV 300/450
A1EGSX

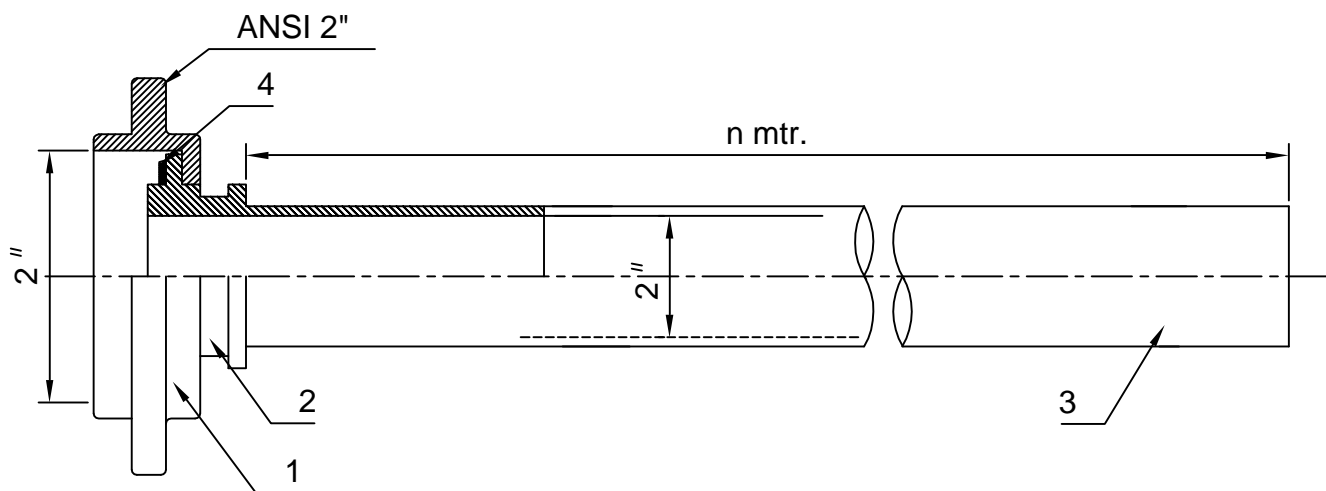

4	1	Packing	Neopr
3	1	Hose, Heliflat	
2	2	Hose nipple	Brass
1	1	Swivel nut	Brass
Item	Qty	Part	Matr.

Date : 05.03.98

Tegn : 4-1326

Name : M.Berge

N Y B O R G A S

N-6230 SYKKYLVEN - NORWAY

Tel: +47 70 25 40 80 - Fax +47 70 25 29 08

E-MAIL: office@nyborgfan.com - WEB: www.nyborgfan.com

MPV 300/450
A1EGSX



AIR DUCT, COLLAPSIBLE

MPV 300/450
A1EGSX

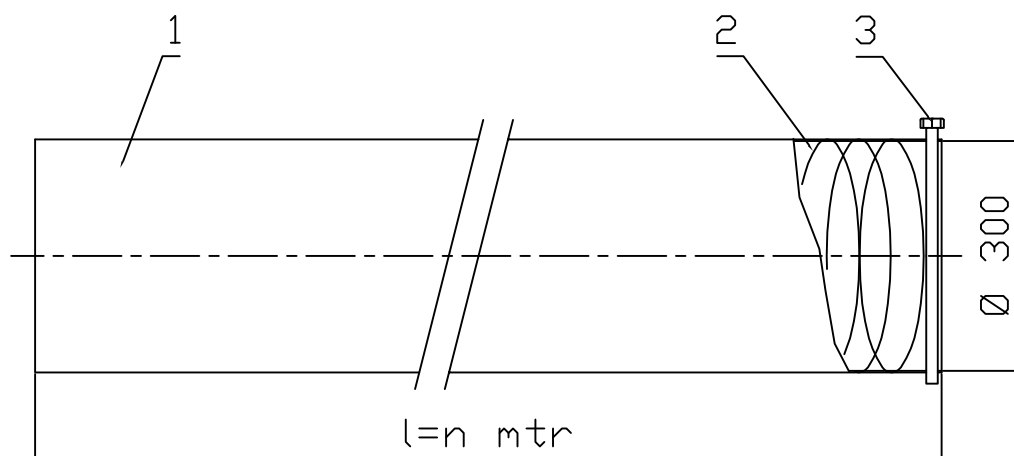

3	1	Hose clamp	St.37
2	1	Wire reinf.	St.37
1	1	Hose	Nylon
Item	Qty	Part/Descript.	Material

Date : 05.03.98

Tegn : 4-1325

Name : M.Berge

N Y B O R G A S

N-6230 SYKKYLVEN - NORWAY

Tel: +47 70 25 40 80 - Fax +47 70 25 29 08

E-MAIL: office@nyborgfan.com - WEB: www.nyborgfan.com

MPV 300/450
A1EGSX



NYBORG AXIAL FLOW FAN PERFORMANCE DATA

MPV 350 A
Imp: A6T / 22

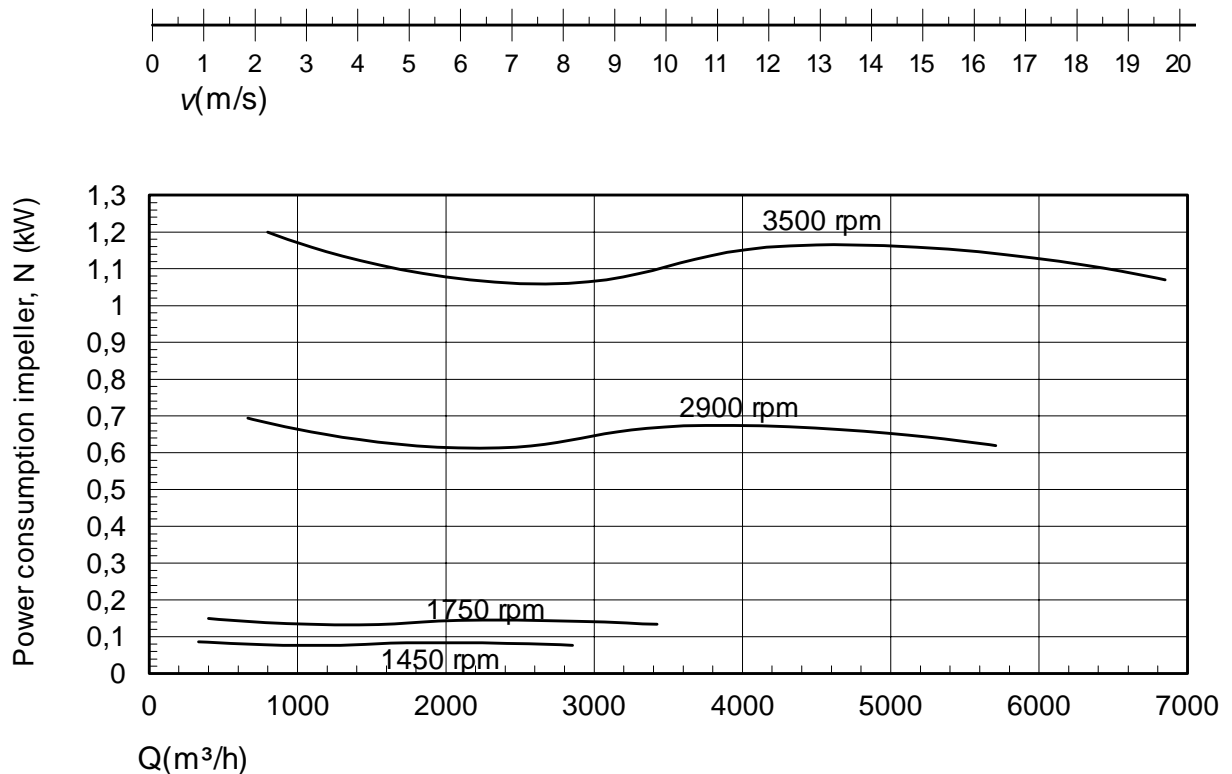
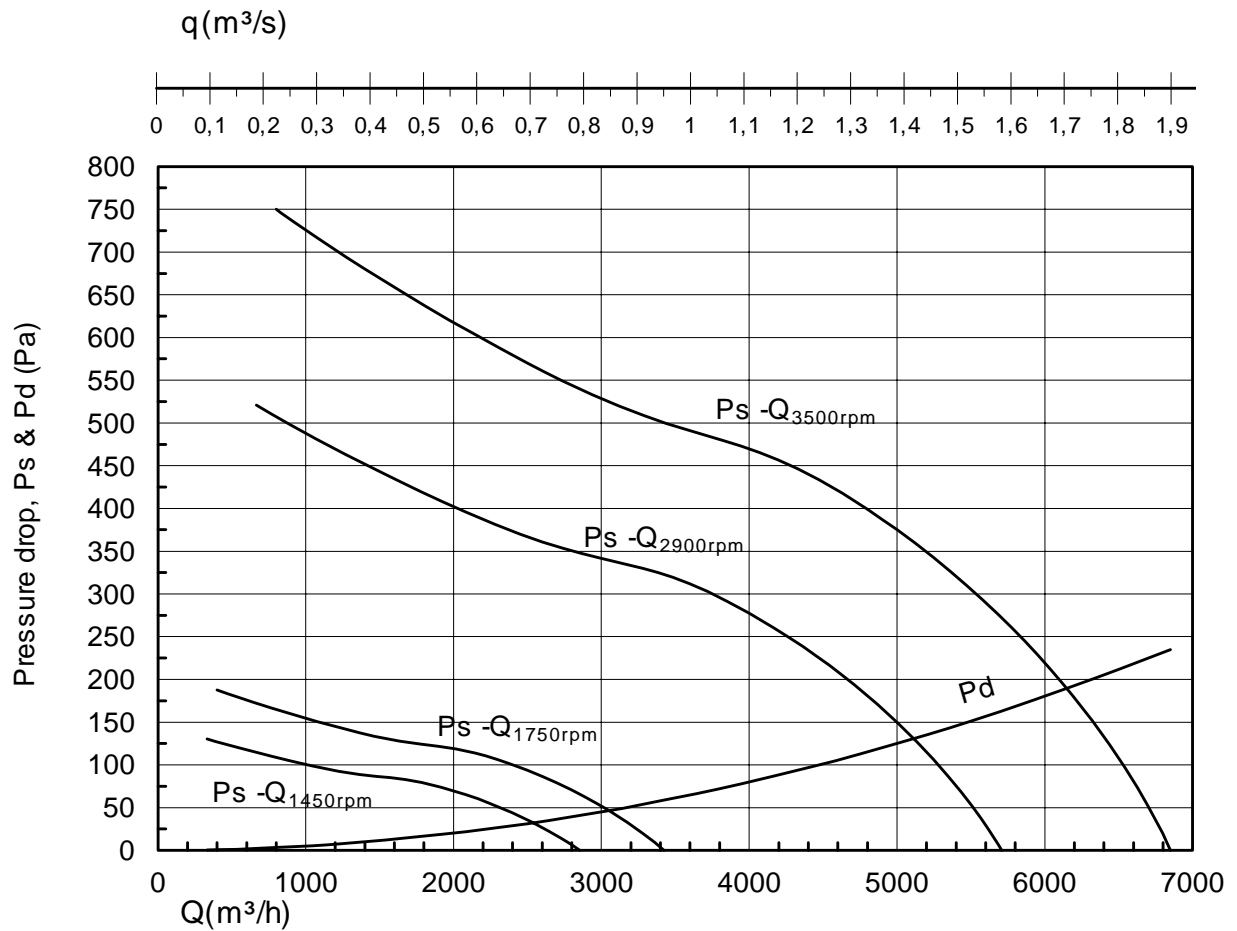

N Y B O R G A S

nyborg12.prs/29

N-6230 SYKKYLVEN, NORWAY
TEL +47 70 25 40 80 - FAX +47 70 25 29 08
E-mail : office@nyborgfan.com - www.nyborgfan.com

MPV 350 A



NYBORG AXIAL FLOW FAN PERFORMANCE DATA

MPV 400 A
Imp: A7T / 22

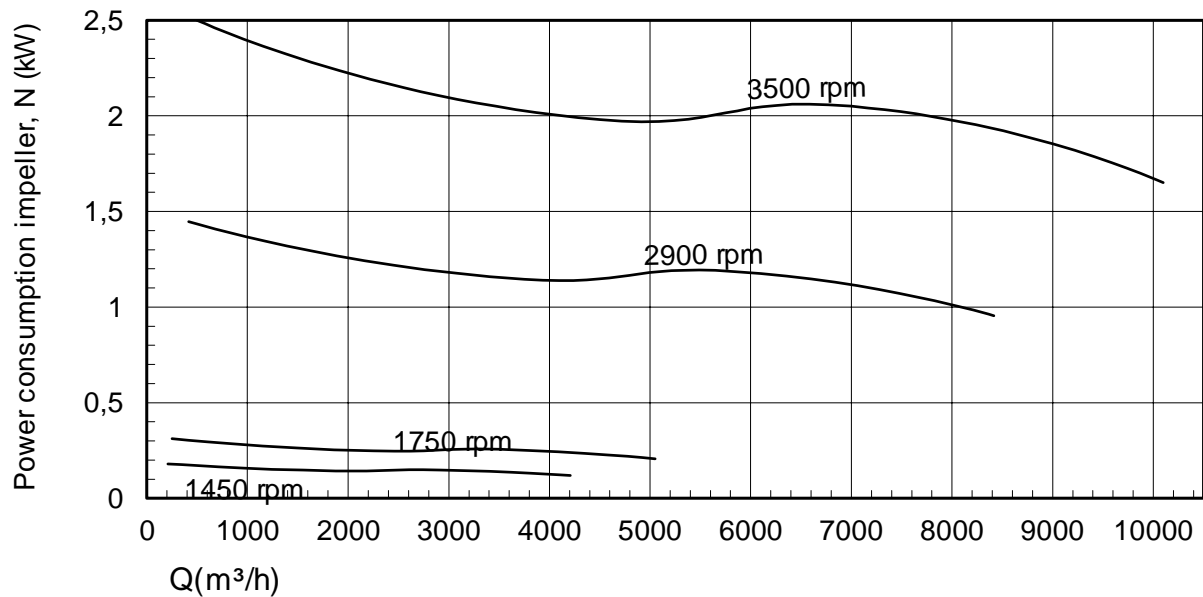
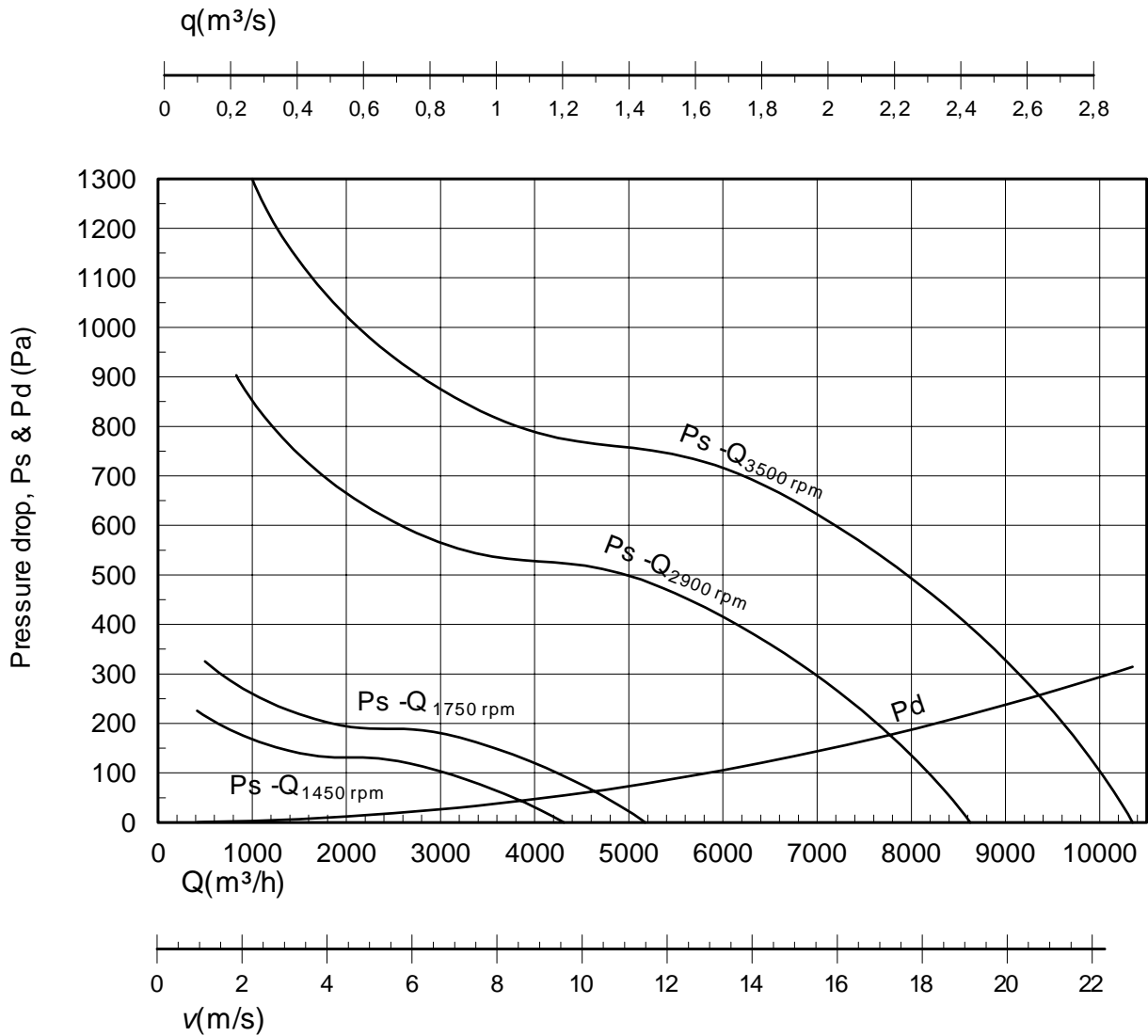

N Y B O R G A S

nyborg12.prs/38

N-6230 SYKKYLVEN, NORWAY
TEL +47 70 25 40 80 - FAX +47 70 25 29 08
office@nyborgfan.com - www.nyborgfan.com

MPV 400 A



NYBORG AXIAL FLOW FAN PERFORMANCE DATA

MPV 450 A
Imp: A7T / 22

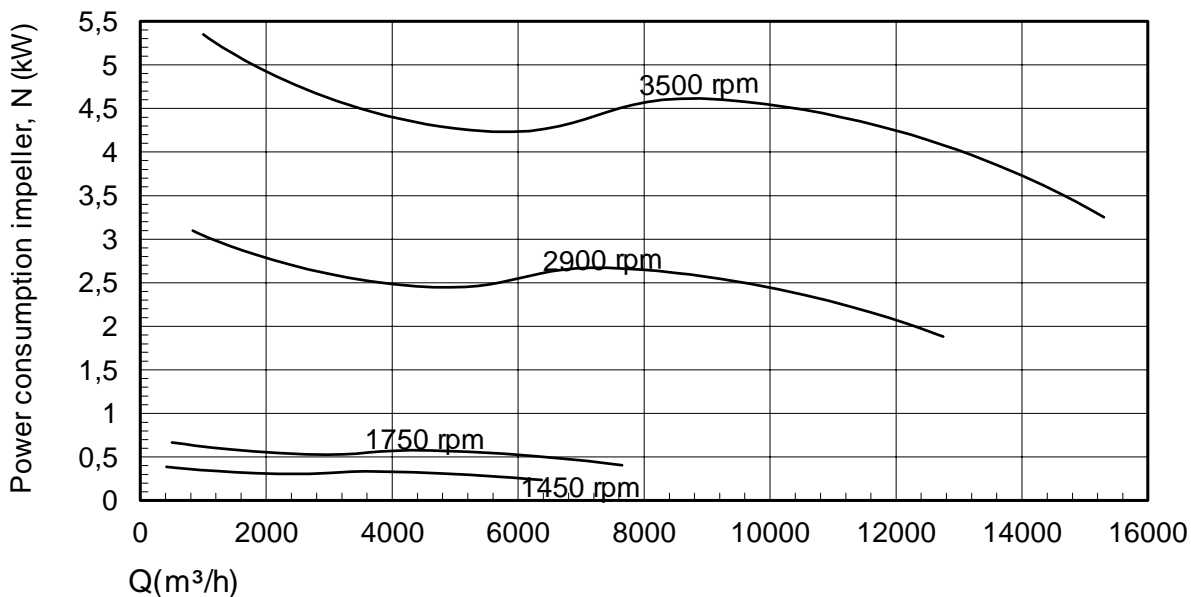
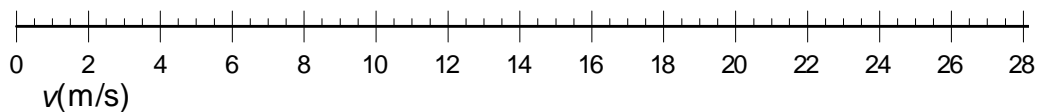
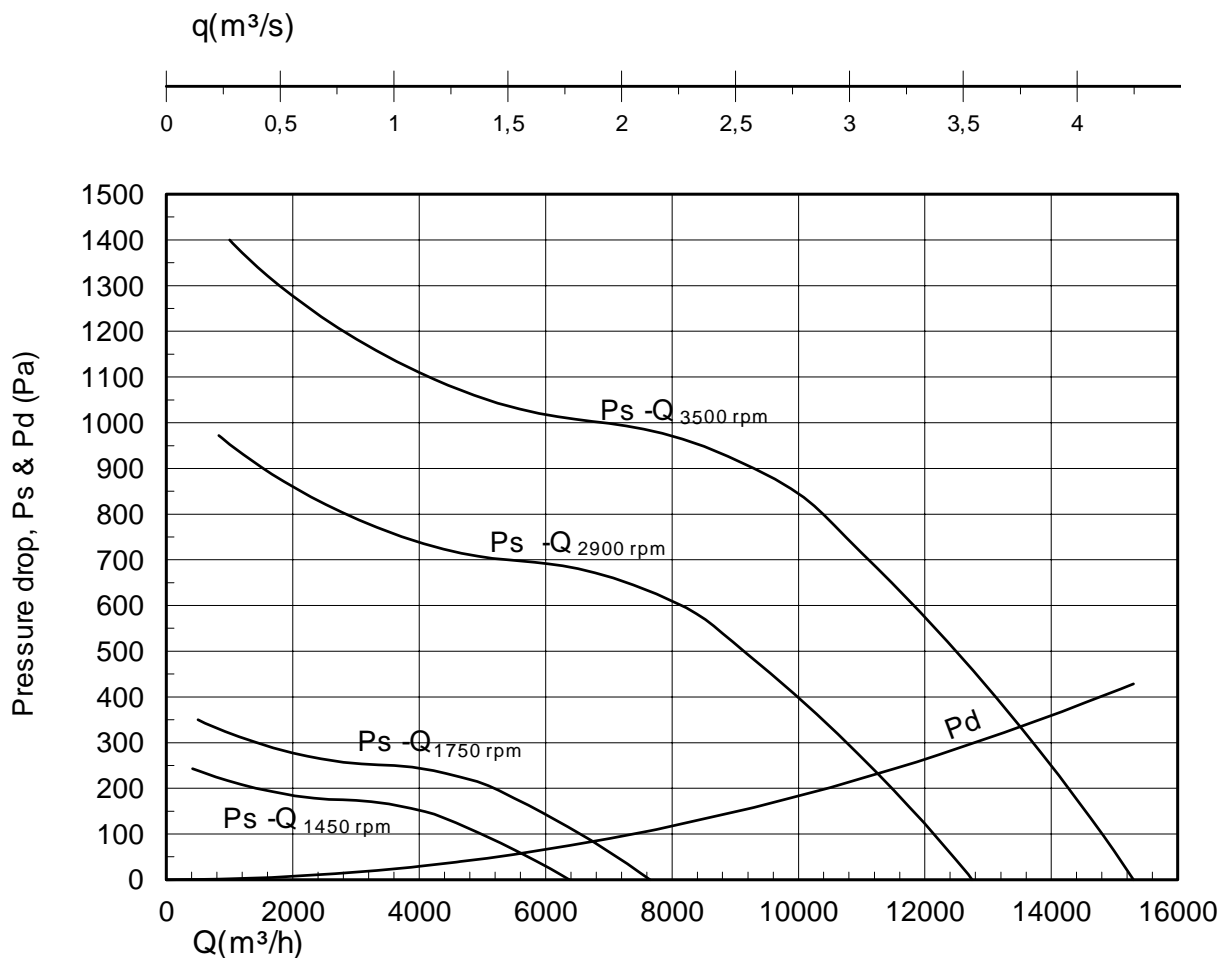

N Y B O R G A S

nyborg12.prs/33

N-6230 SYKKYLVEN, NORWAY
TEL +47 70 25 40 80 - FAX +47 70 25 29 08
office@nyborgfan.com - www.nyborgfan.com

MPV 450 A



NYBORG AXIAL FLOW FAN PERFORMANCE DATA

MPV 500 A
Imp: A7T / 22

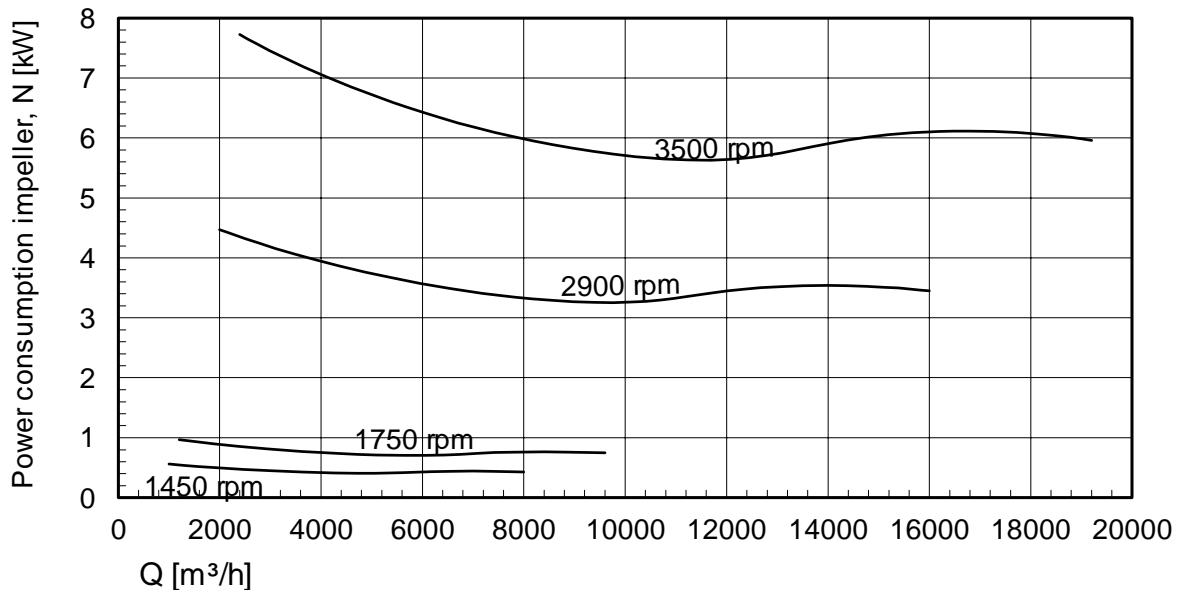
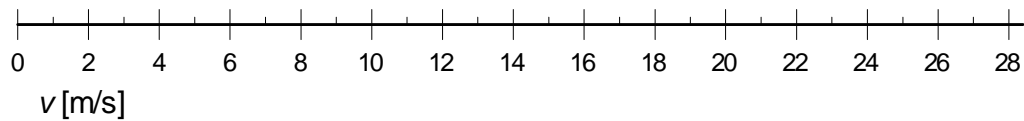
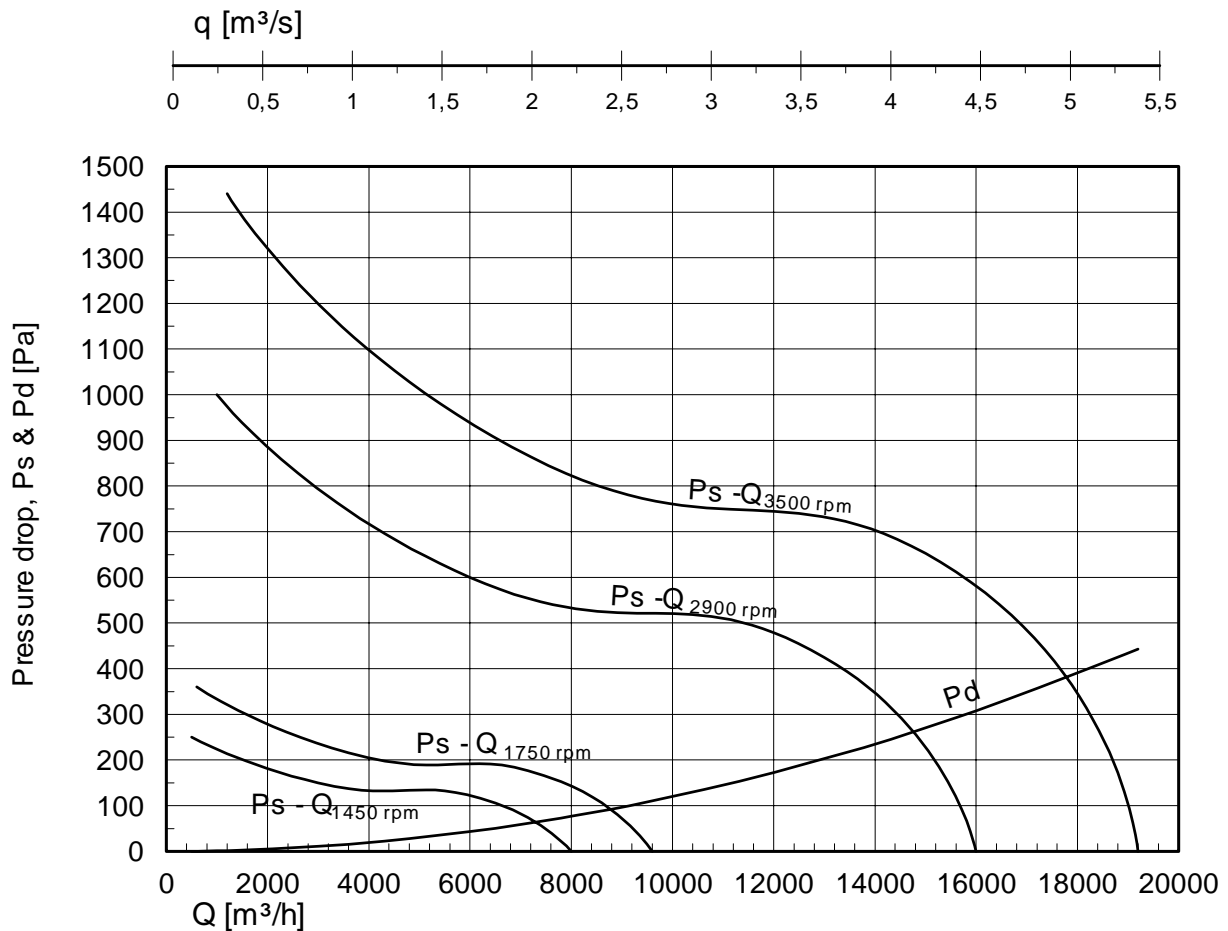

N Y B O R G A S

nyborg12.prs/13

N-6230 SYKKYLVEN, NORWAY
TEL +47 70 25 40 80 - FAX +47 70 25 29 08
office@nyborgfan.com - www.nyborgfan.com

MPV 500 A



NYBORG PORTABLE AXIAL FLOW FAN WATER CONSUMPTION CHART

MPV - A1EGSX

WATER MOTOR : GILKES 3,25F WM 0,10 VENT

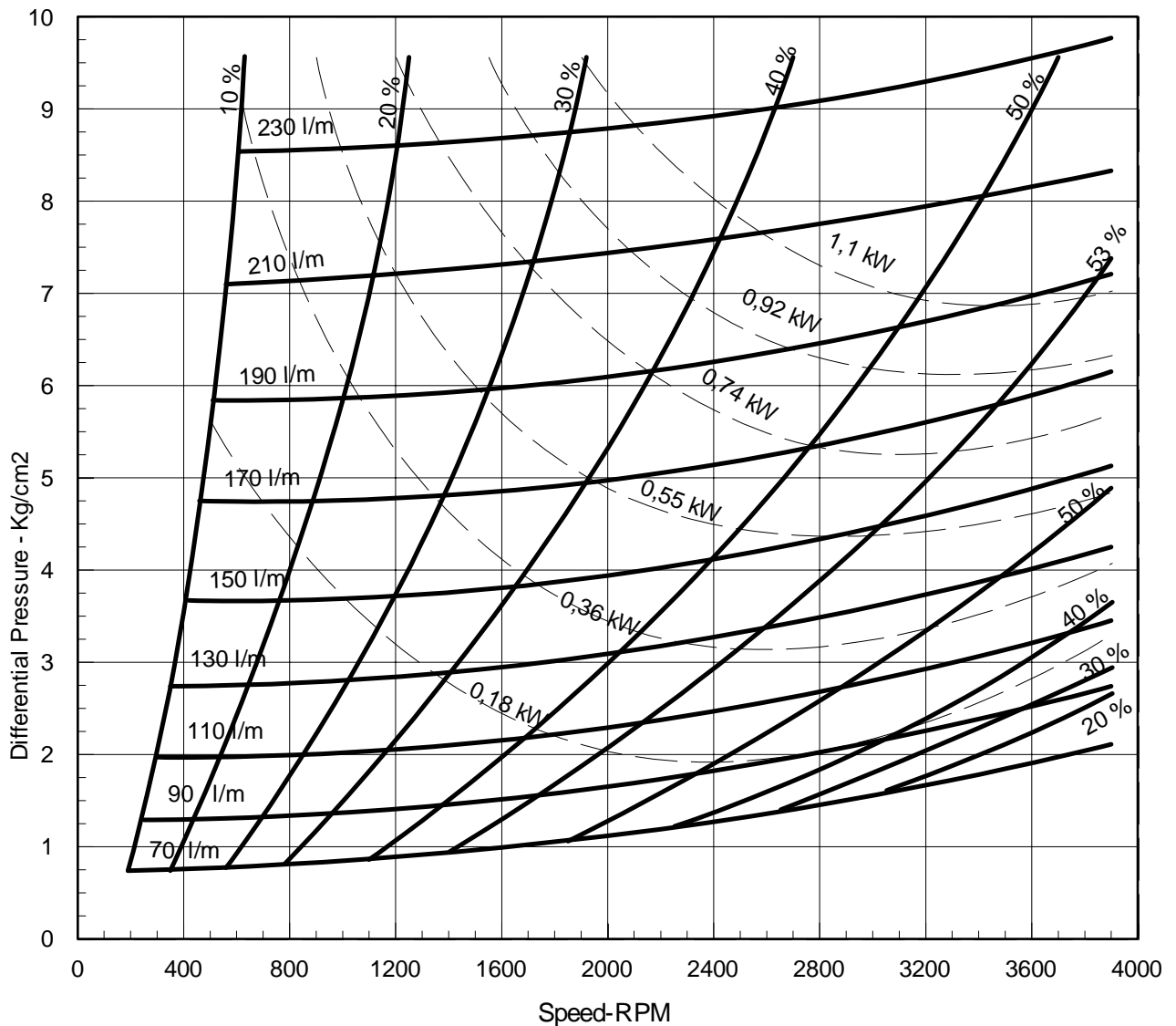

N Y B O R G A S

N-6230 SYKKYLVEN, NORWAY
TEL +47 70 25 40 80 - FAX +47 70 25 29 08
office@nyborgfan.com - www.nyborgfan.com

MPV - A1EGSX



NYBORG PORTABLE AXIAL FLOW FAN WATER CONSUMPTION CHART

MPV - A1EGSX

WATER MOTOR : GILKES 3,25F WM 0,15 VENT

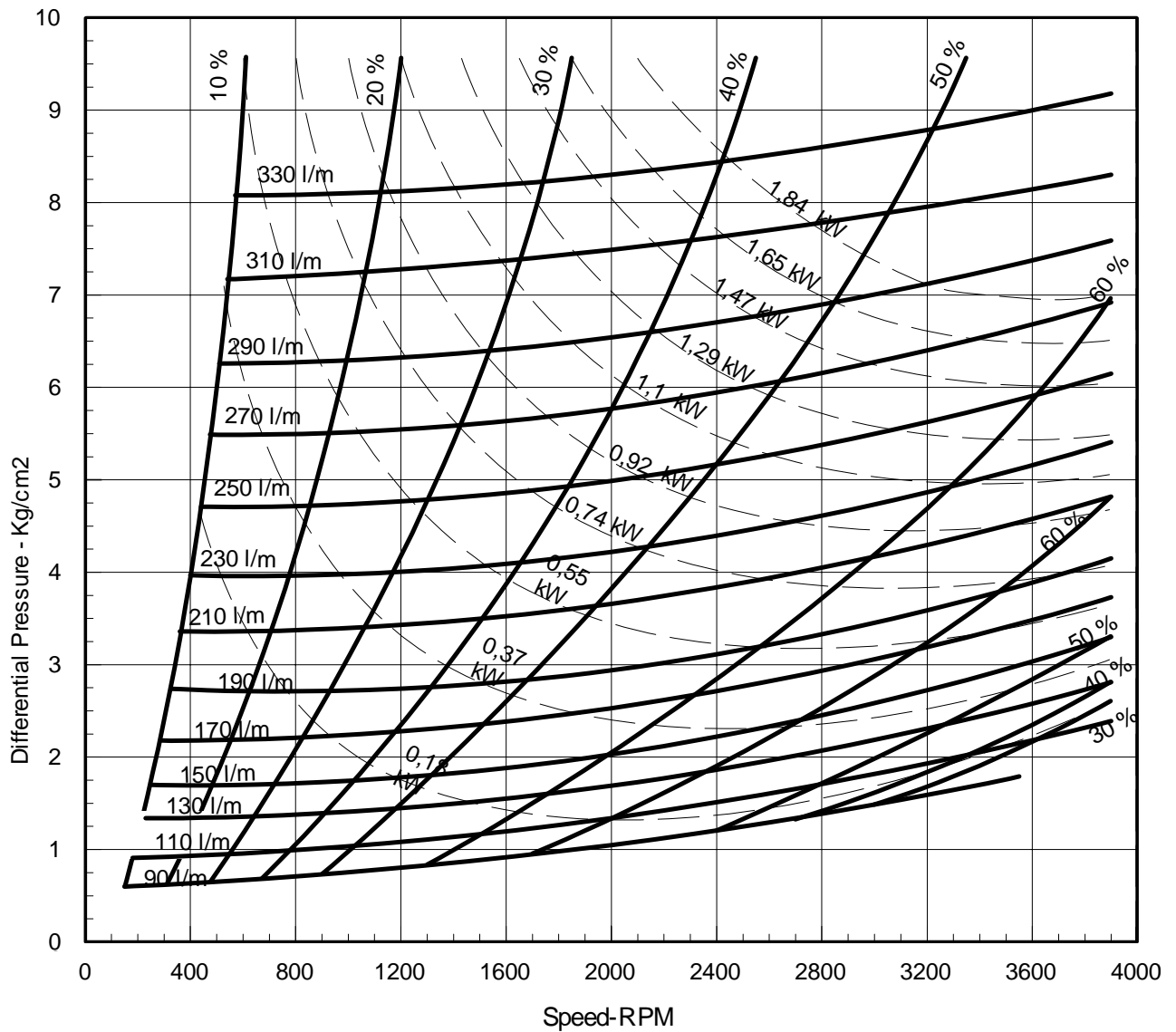

N Y B O R G A S

N-6230 SYKKYLVEN, NORWAY
TEL +47 70 25 40 80 - FAX +47 70 25 29 08
office@nyborgfan.com - www.nyborgfan.com

MPV - A1EGSX



NYBORG PORTABLE AXIAL FLOW FAN WATER CONSUMPTION CHART

**MPV -
A1EGSX**

WATER MOTOR : GILKES 3,25F WM 0,20 VENT

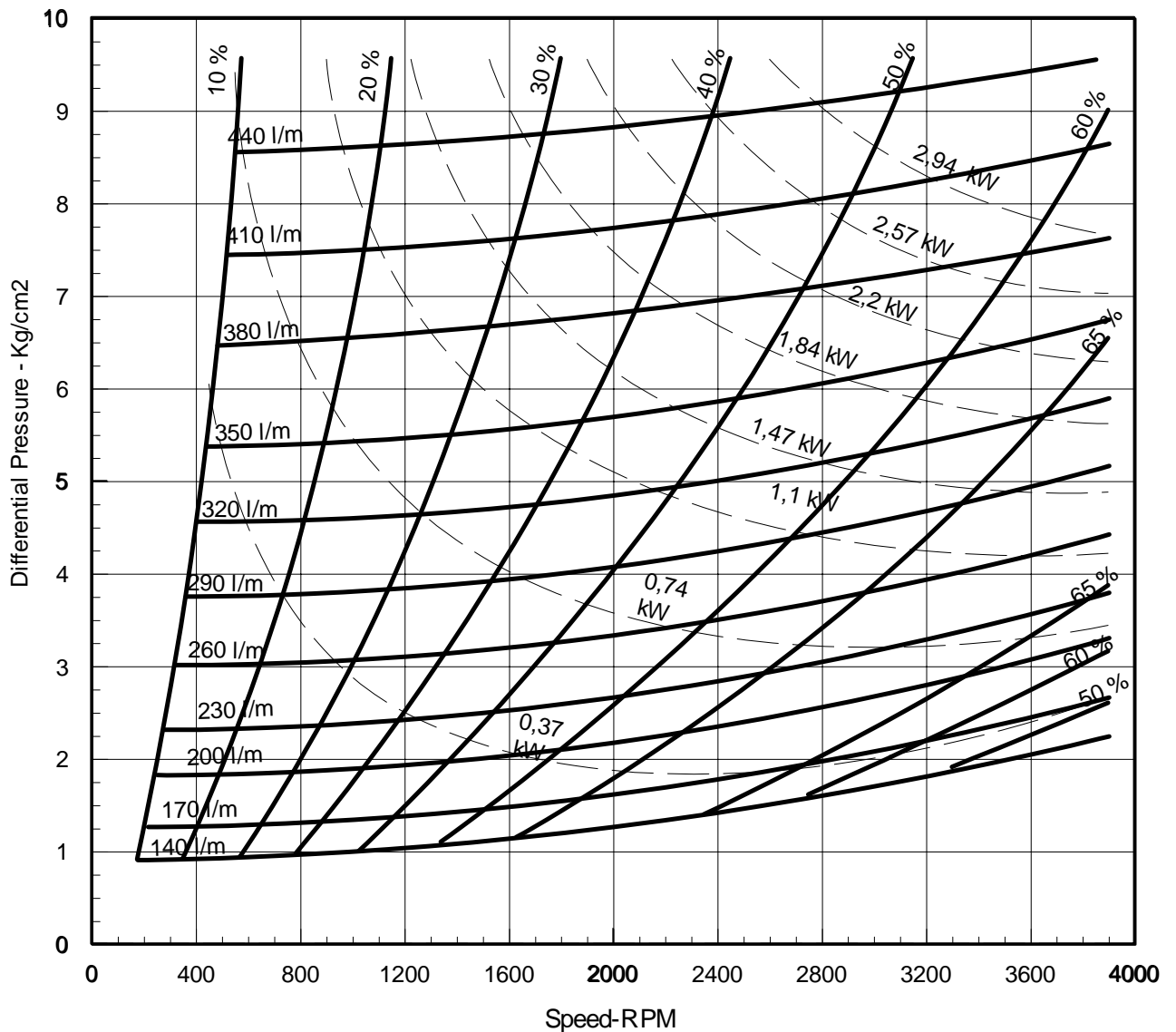

N Y B O R G A S

N-6230 SYKKYLVEN, NORWAY
TEL +47 70 25 40 80 - FAX +47 70 25 29 08
office@nyborgfan.com - www.nyborgfan.com

**MPV -
A1EGSX**



NYBORG PORTABLE AXIAL FLOW FAN WATER CONSUMPTION CHART

MPV - A1EGSX

WATER MOTOR : GILKES 3,25F WM 0,25 VENT

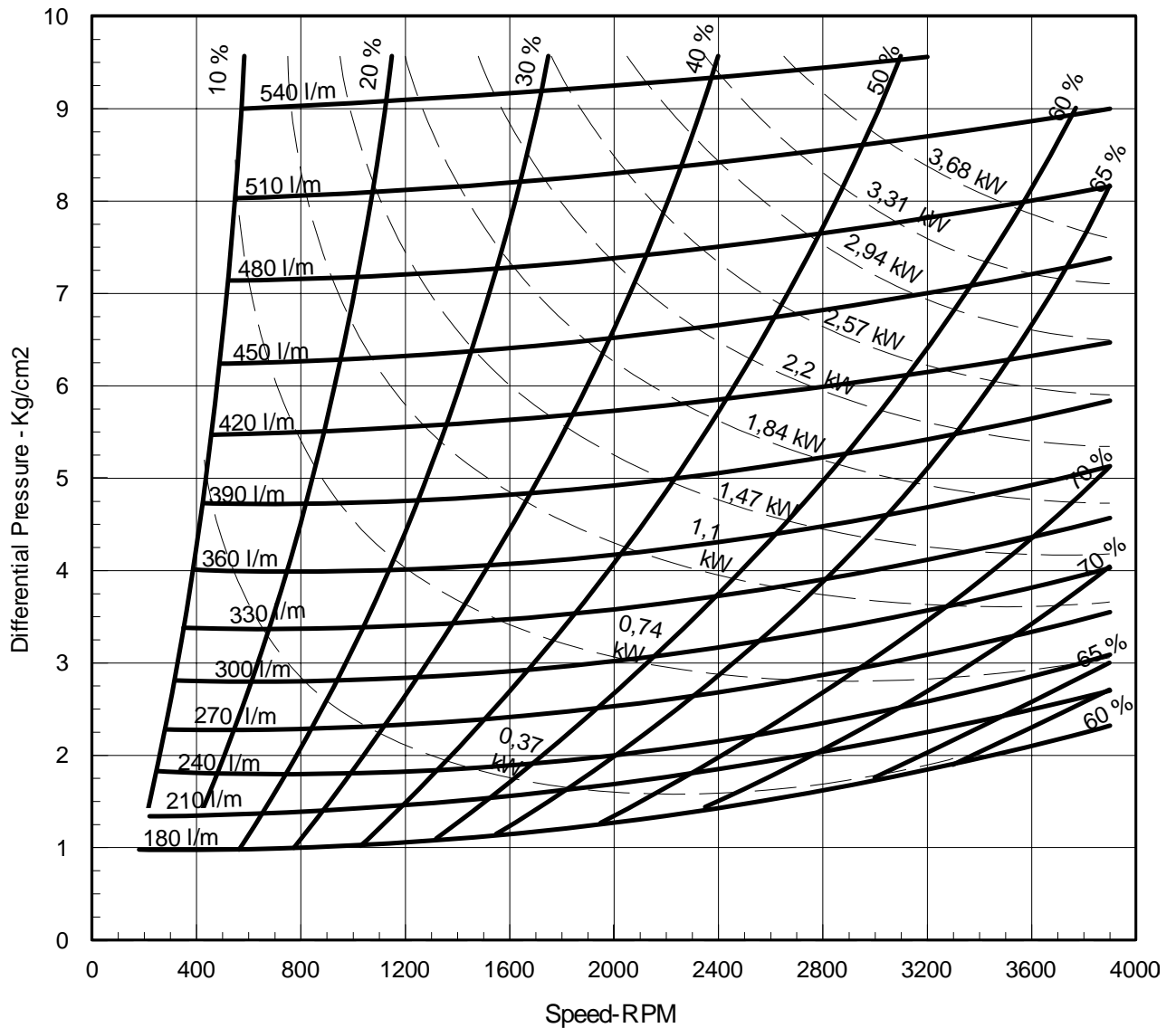

N Y B O R G A S

N-6230 SYKKYLVEN, NORWAY
TEL +47 70 25 40 80 - FAX +47 70 25 29 08
office@nyborgfan.com - www.nyborgfan.com

MPV - A1EGSX



NYBORG PORTABLE AXIAL FLOW FAN WATER CONSUMPTION CHART

**MPV -
A1EGSX**

WATER MOTOR : GILKES 3,25F WM 0,30 VENT

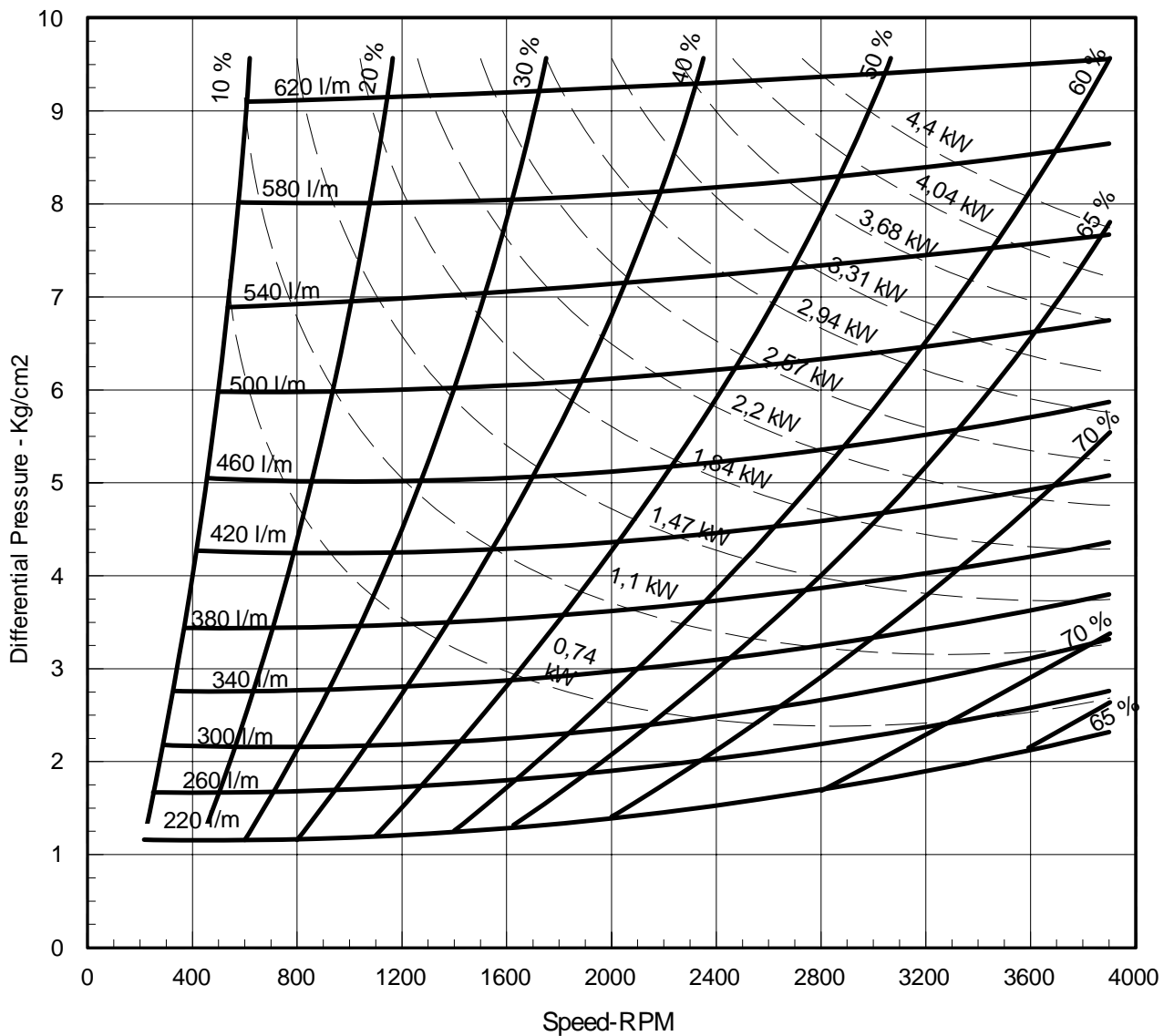

N Y B O R G A S

N-6230 SYKKYLVEN, NORWAY
TEL +47 70 25 40 80 - FAX +47 70 25 29 08
office@nyborgfan.com - www.nyborgfan.com

**MPV -
A1EGSX**



NYBORG PORTABLE AXIAL FLOW FAN WATER CONSUMPTION CHART

MPV - A1EGSX

WATER MOTOR : GILKES 4,25F WM 0,10 VENT

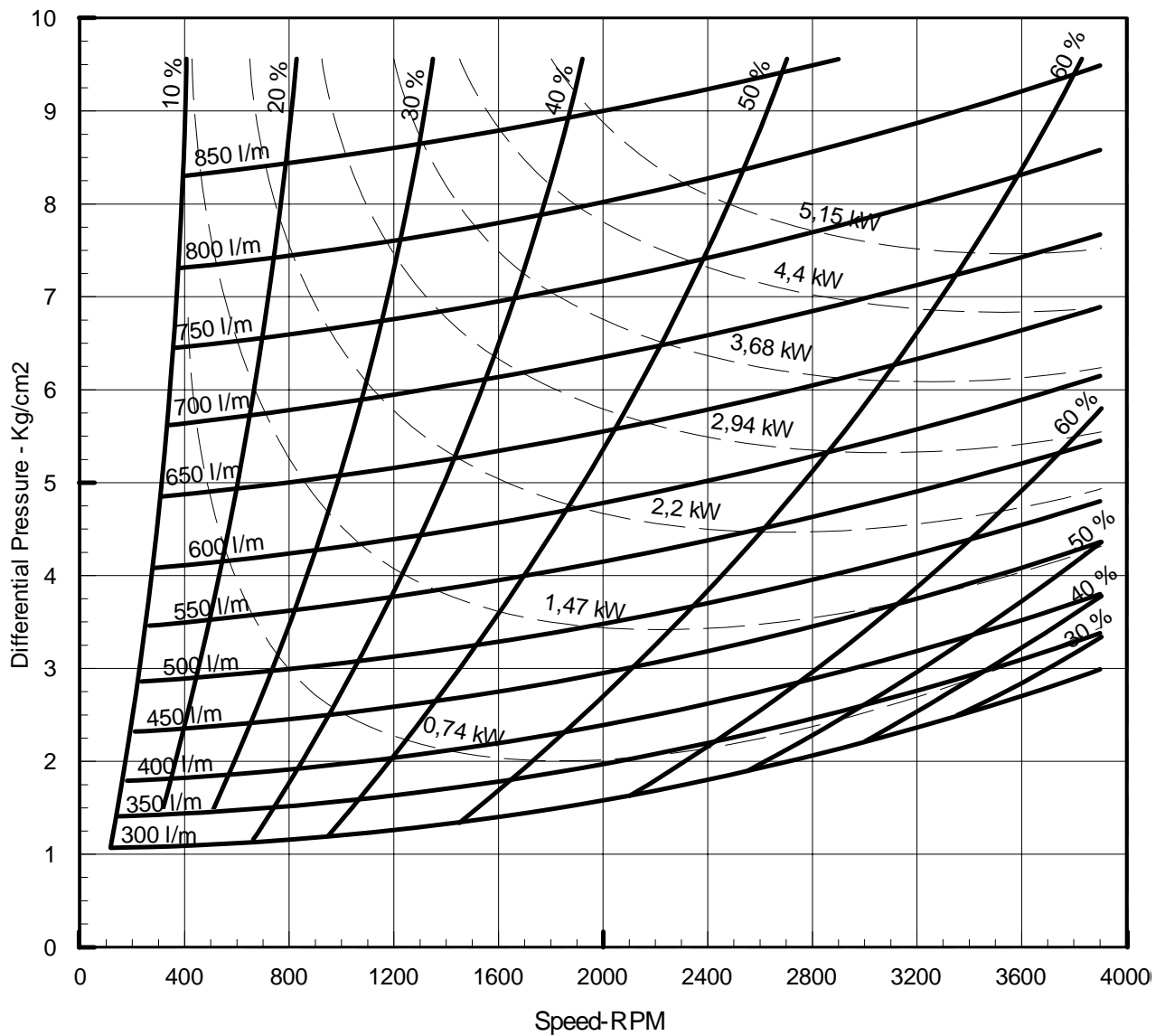

N Y B O R G A S

N-6230 SYKKYLVEN, NORWAY
TEL +47 70 25 40 80 - FAX +47 70 25 29 08
office@nyborgfan.com - www.nyborgfan.com

MPV - A1EGSX



NYBORG PORTABLE AXIAL FLOW FAN WATER CONSUMPTION CHART

MPV - A1EGSX

WATER MOTOR : GILKES 4,25F WM 0,20 VENT

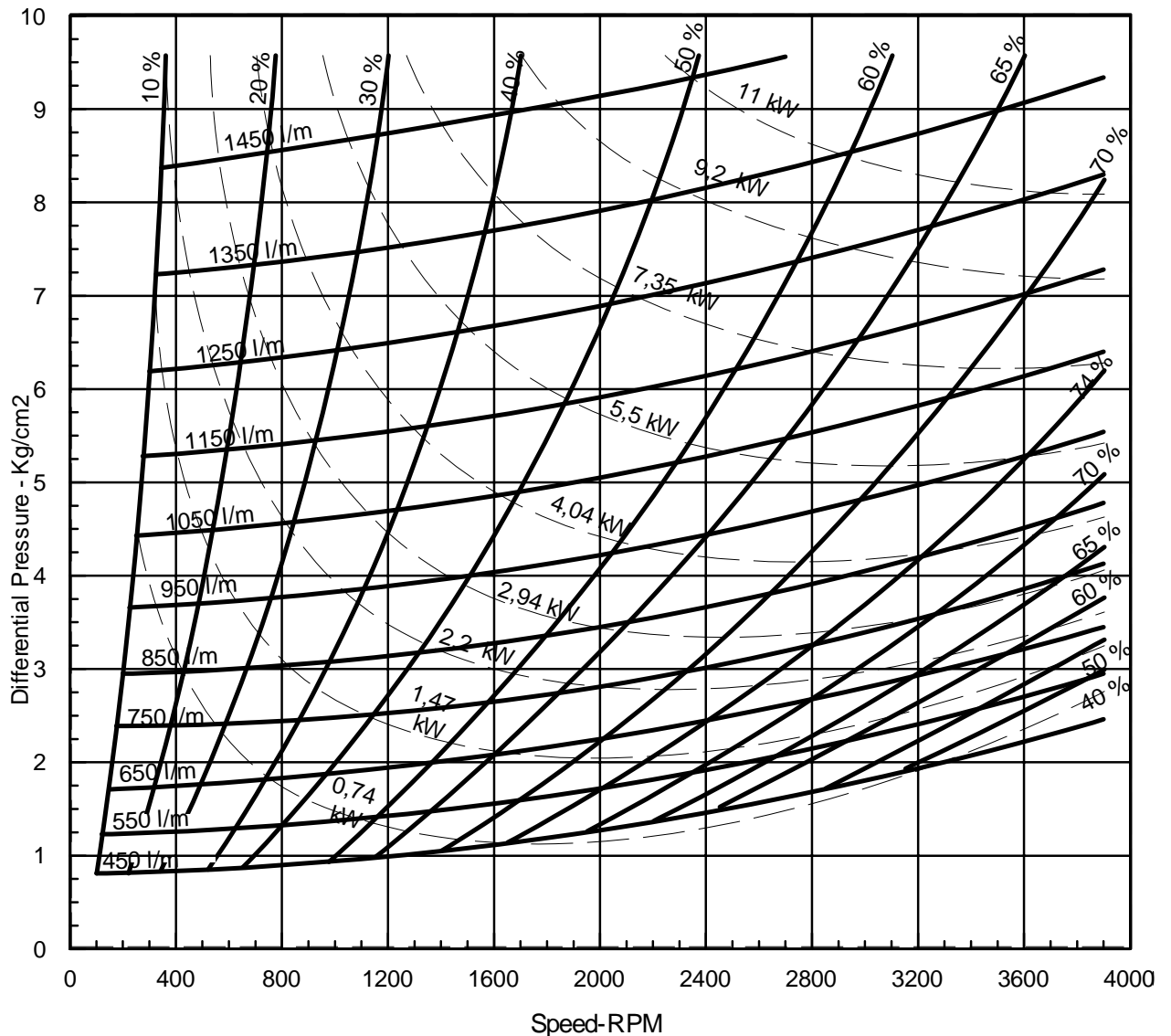

N Y B O R G A S

N-6230 SYKKYLVEN, NORWAY
TEL +47 70 25 40 80 - FAX +47 70 25 29 08
office@nyborgfan.com - www.nyborgfan.com

MPV - A1EGSX



NYBORG PORTABLE AXIAL FLOW FAN WATER CONSUMPTION CHART

MPV - A1EGSX

WATER MOTOR : GILKES 4,25F WM 0,30 VENT

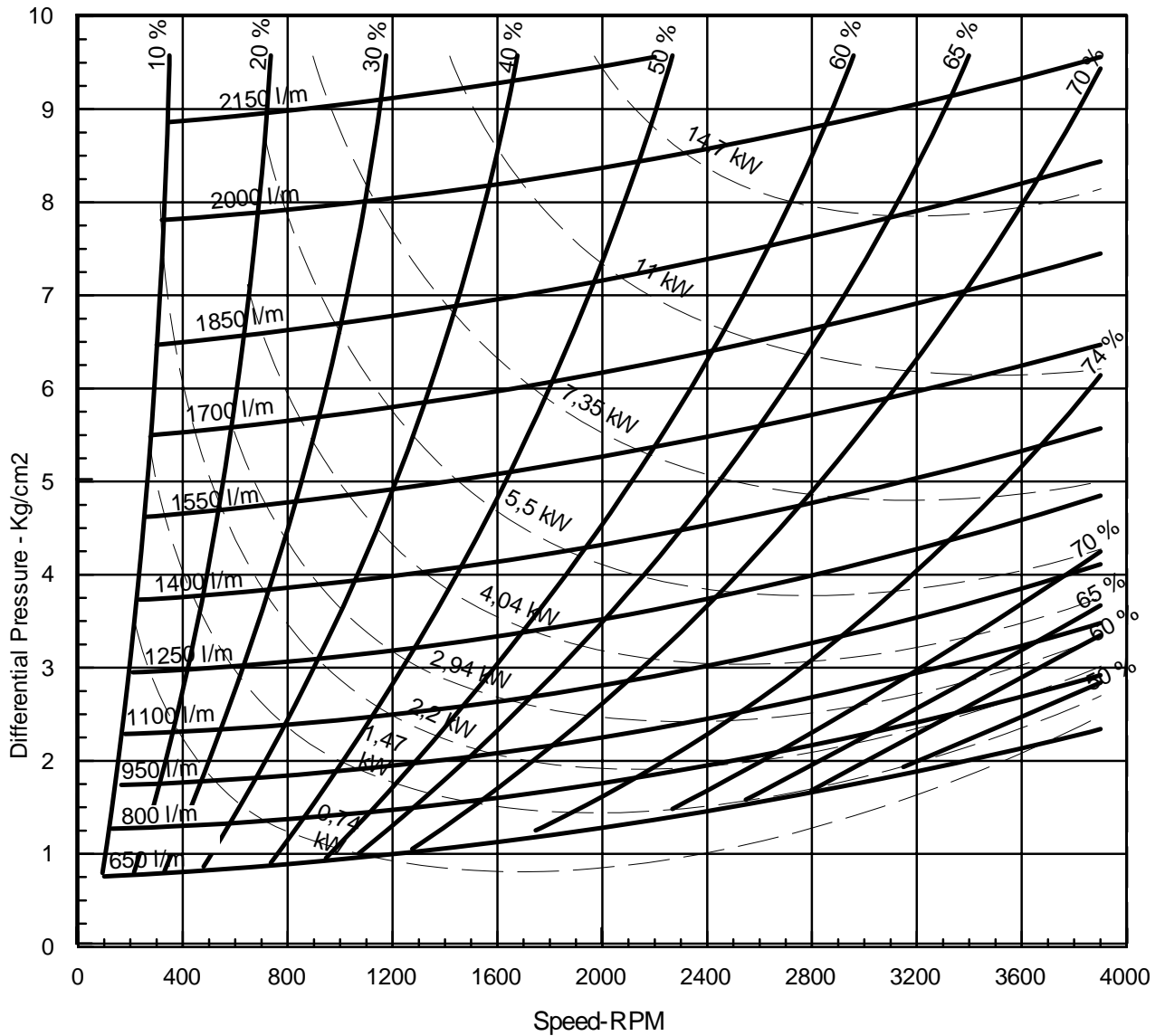

N Y B O R G A S

N-6230 SYKKYLVEN, NORWAY
TEL +47 70 25 40 80 - FAX +47 70 25 29 08
office@nyborgfan.com - www.nyborgfan.com

MPV - A1EGSX



NYBORG PORTABLE AXIAL FLOW FAN WATER CONSUMPTION CHART

MPV - A1EGSX

WATER MOTOR : GILKES 4,25F WM 0,40 VENT

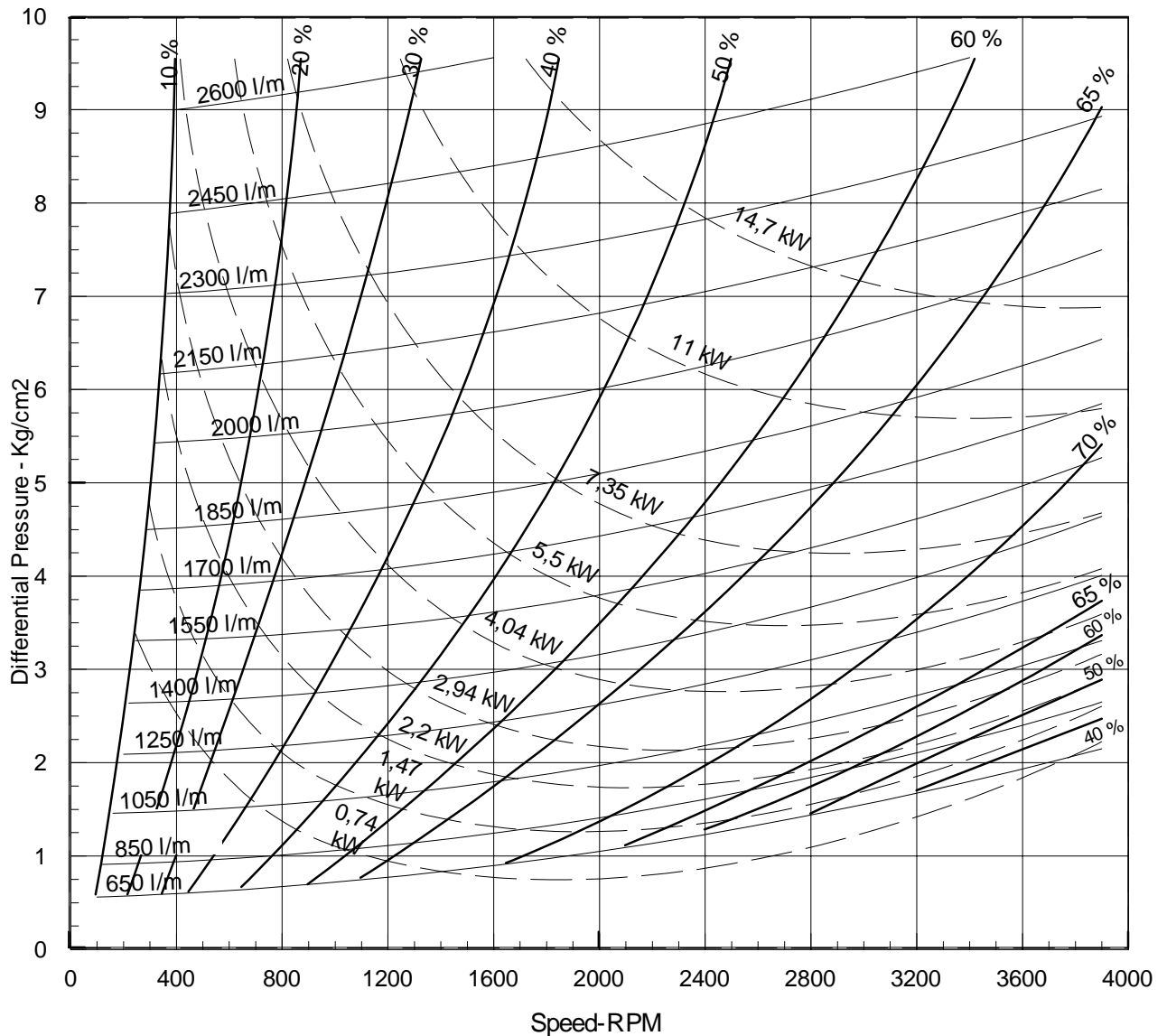

N Y B O R G A S

N-6230 SYKKYLVEN, NORWAY
TEL +47 70 25 40 80 - FAX +47 70 25 29 08
office@nyborgfan.com - www.nyborgfan.com

MPV - A1EGSX